

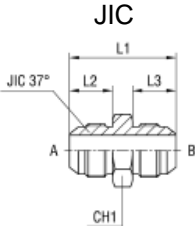

Nichtmetrische Adapter

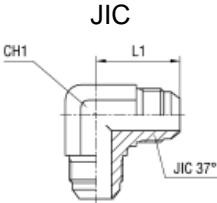

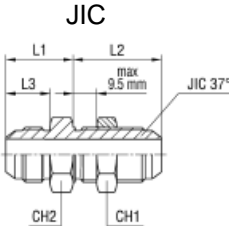
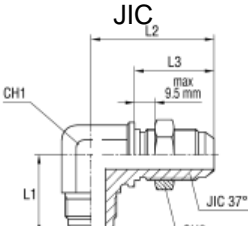
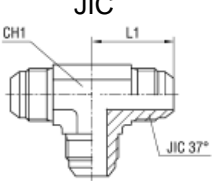
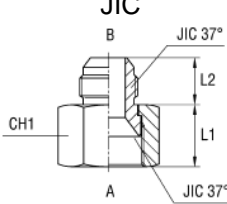
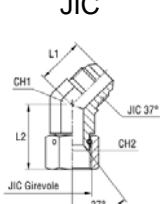
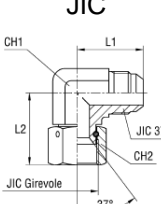
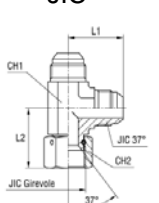
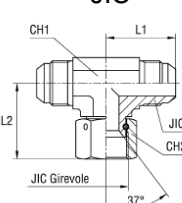
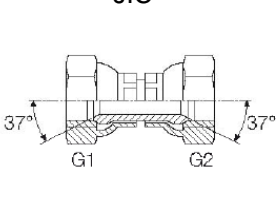
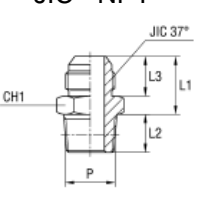
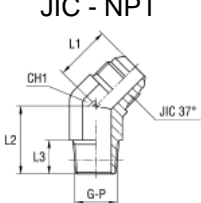
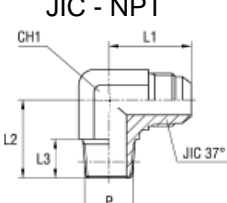
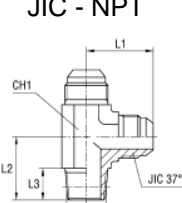
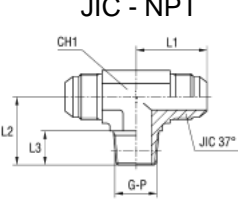
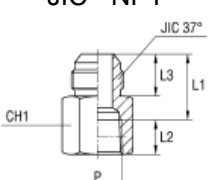
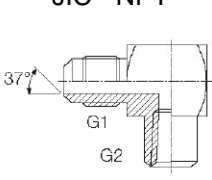
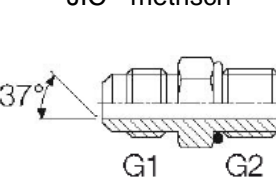
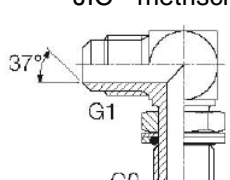
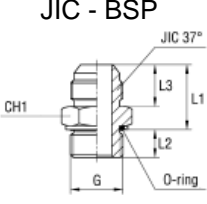
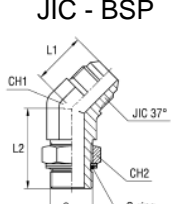
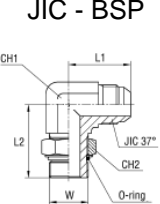
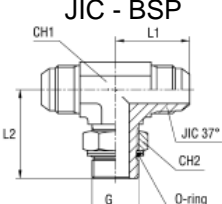

Inhaltsverzeichnis:

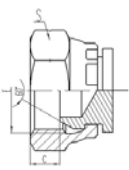
Bildübersicht	Seite 2 – 5
Gewindearten	Seite 6 – 7
JIC – Adapter	Seite 8 – 20
BSP – Adapter	Seite 21 – 33
NPT – Adapter	Seite 34 – 37
ORFS – Adapter	Seite 38 – 45
Komatsu – Adapter	Seite 46 – 48

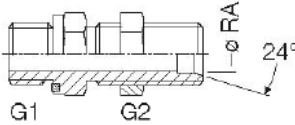
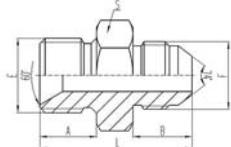
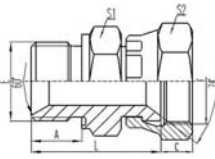
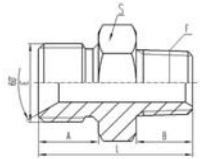
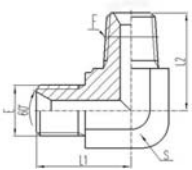
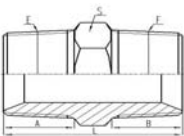
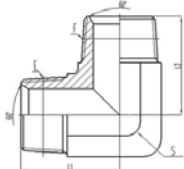
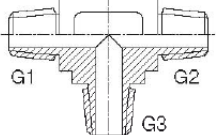
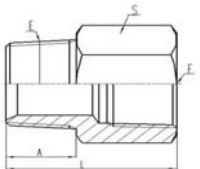
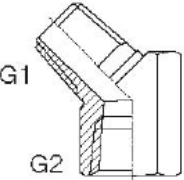
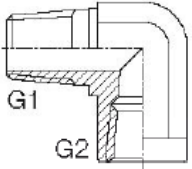
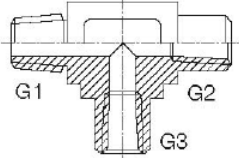
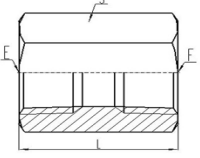
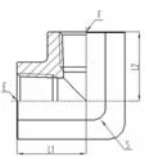
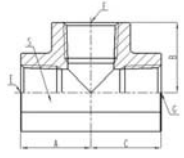
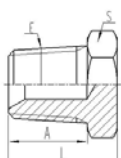
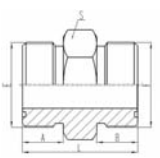
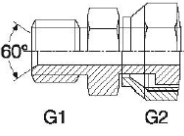
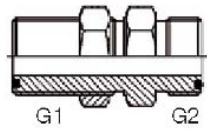
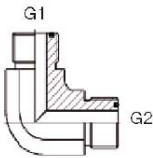
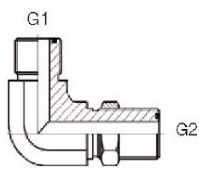
 <p>JIC</p> <p>Seite 8</p>	 <p>JIC</p> <p>Seite 8</p>	 <p>JIC</p> <p>Seite 9</p>	 <p>JIC</p> <p>Seite 9</p>
 <p>JIC</p> <p>Seite 9</p>	 <p>JIC</p> <p>Seite 10</p>	 <p>JIC</p> <p>Seite 10</p>	 <p>JIC</p> <p>Seite 11</p>
 <p>JIC</p> <p>Seite 11</p>	 <p>JIC</p> <p>Seite 11</p>	 <p>JIC</p> <p>Seite 12</p>	 <p>JIC - NPT</p> <p>Seite 13</p>
 <p>JIC - NPT</p> <p>Seite 14</p>	 <p>JIC - NPT</p> <p>Seite 14</p>	 <p>JIC - NPT</p> <p>Seite 15</p>	 <p>JIC - NPT</p> <p>Seite 15</p>
 <p>JIC - NPT</p> <p>Seite 15</p>	 <p>JIC - NPT</p> <p>Seite 16</p>	 <p>JIC - metrisch</p> <p>Seite 16</p>	 <p>JIC - metrisch</p> <p>Seite 16</p>
 <p>JIC - BSP</p> <p>Seite 17</p>	 <p>JIC - BSP</p> <p>Seite 17</p>	 <p>JIC - BSP</p> <p>Seite 18</p>	 <p>JIC - BSP</p> <p>Seite 19</p>

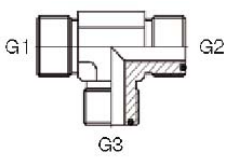
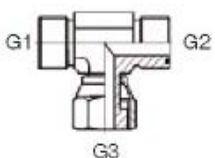
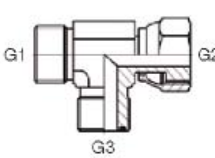
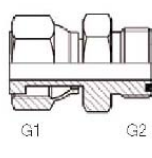
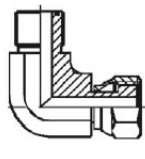
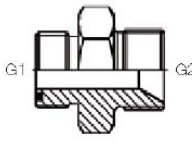
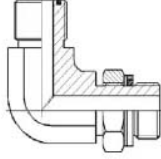
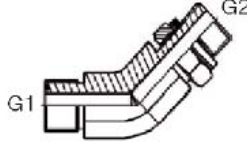
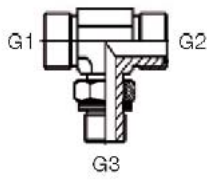
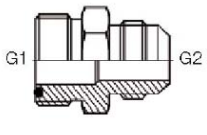
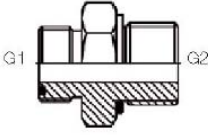
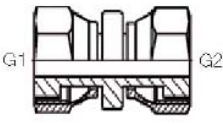
<p>BSP</p>  <p>Seite 30</p>	<p>BSP</p>  <p>Seite 30</p>	<p>BSP - metrisch</p>  <p>Seite 31</p>	<p>BSP - JIC</p>  <p>Seite 32</p>
<p>BSP - JIC</p>  <p>Seite 32</p>	<p>BSP - NPT</p>  <p>Seite 33</p>	<p>BSP - NPT</p>  <p>Seite 33</p>	
<p>NPT</p>  <p>Seite 34</p>	<p>NPT</p>  <p>Seite 34</p>	<p>NPT</p>  <p>Seite 35</p>	<p>NPT</p>  <p>Seite 35</p>
<p>NPT</p>  <p>Seite 35</p>	<p>NPT</p>  <p>Seite 36</p>	<p>NPT</p>  <p>Seite 36</p>	<p>NPT</p>  <p>Seite 36</p>
<p>NPT</p>  <p>Seite 37</p>	<p>NPT</p>  <p>Seite 37</p>	<p>NPT</p>  <p>Seite 37</p>	<p>ORFS</p>  <p>Seite 38</p>
<p>ORFS - BSP</p>  <p>Seite 38</p>	<p>ORFS</p>  <p>Seite 38</p>	<p>ORFS</p>  <p>Seite 39</p>	<p>ORFS</p>  <p>Seite 39</p>

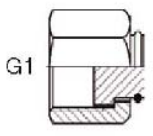
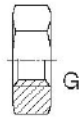
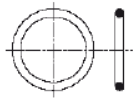
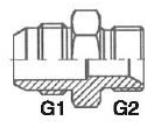
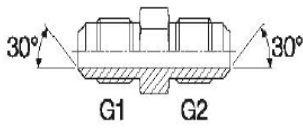
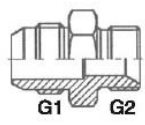
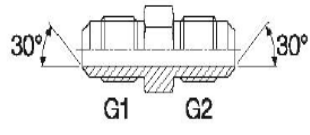
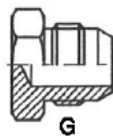
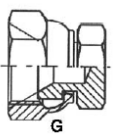
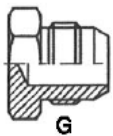
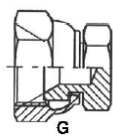
<p>ORFS</p>  <p>Seite 39</p>	<p>ORFS</p>  <p>Seite 40</p>	<p>ORFS</p>  <p>Seite 40</p>	<p>ORFS</p>  <p>Seite 40</p>
<p>ORFS</p>  <p>Seite 41</p>	<p>ORFS - BSP</p>  <p>Seite 41</p>	<p>ORFS - BSP</p>  <p>Seite 41</p>	<p>ORFS - BSP</p>  <p>Seite 42</p>
<p>ORFS - BSP</p>  <p>Seite 42</p>	<p>ORFS - JIC</p>  <p>Seite 42</p>	<p>ORFS - metrisch</p>  <p>Seite 43</p>	<p>ORFS</p>  <p>Seite 43</p>
<p>ORFS</p>  <p>Seite 44</p>	<p>ORFS</p>  <p>Seite 44</p>	<p>ORFS</p>  <p>Seite 44</p>	<p>ORFS</p>  <p>Seite 45</p>
<p>Komatsu</p>  <p>Seite 46</p>	<p>Komatsu</p>  <p>Seite 46</p>	<p>Komatsu</p>  <p>Seite 47</p>	<p>Komatsu</p>  <p>Seite 47</p>
<p>Komatsu</p>  <p>Seite 48</p>	<p>Komatsu</p>  <p>Seite 48</p>	<p>Komatsu</p>  <p>Seite 48</p>	<p>Komatsu</p>  <p>Seite 48</p>

Gewindetabellen:

BSP – Anschluß

Withworth – Rohrgewinde mit 60° Dichtkegel

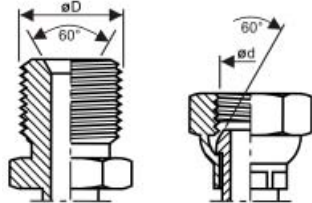

Gewinde:	Außen $\varnothing D$	Innen $\varnothing d$	Size	NW
1/8"	9,7	8,6	2	5
1/4"	13,2	11,4	4	6
3/8"	16,7	15,0	6	10
1/2"	21,0	18,6	8	12
5/8"	22,9	20,6	10	16
3/4"	26,4	24,1	12	20
1"	33,3	30,3	16	25
1.1/4"	41,9	39,0	20	32
1.1/2"	47,8	44,9	24	40
2"	59,6	56,7	32	50

JIC – Anschluß

UN (UNF) – Gewinde mit 74° Dichtkegel

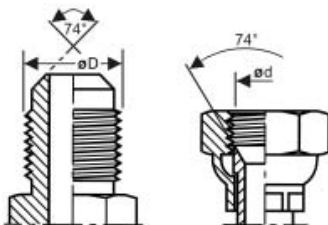

Gewinde:	Außen $\varnothing D$	Innen $\varnothing d$	JIC Size	SAE Size
7/16-20	11,07	10,00	4	4
1/2-20	12,70	11,60	5	5
9/16-18	14,25	13,00	6	-
5/8-18	18,85	14,70	-	6
3/4-16	19,00	17,60	8	-
7/8-14	22,17	20,50	10	8
1.1/16-12	26,95	25,00	12	10
1.1/16-14	26,95	25,30	-	-
1.5/16-12	33,30	31,30	16	12
1.5/8-12	41,22	39,20	20	-
1.7/8-12	47,57	45,60	24	-
2.1/2-12	63,45	61,50	32	-
3-12	76,20	74,30	40	-
3.1/2-12	88,90	87,00	48	-

ORFS – Anschluß

UN (UNF, UNS) – Gewinde flachdichtend
Außengewinde stirnseitig mit O-Ring

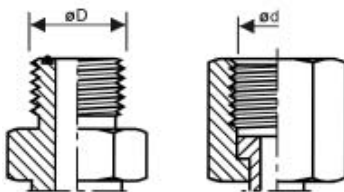

Gewinde:	Außen $\varnothing D$	Innen $\varnothing d$	O-Ring	Size	NW
9/16-18	14,3	12,8	7,66 x 1,78	4	6
11/16-16	17,5	15,7	9,25 x 1,78	6	10
13/16-16	20,6	18,9	12,42 x 1,78	8	12
1-14	25,4	23,4	15,60 x 1,78	10	16
1.3/16-12	30,2	27,9	18,77 x 1,78	12	20
1.7/16-12	36,5	34,2	23,52 x 1,78	16	25
1.11/16-12	42,9	40,6	29,87 x 1,78	20	32
2-12	50,8	48,5	37,82 x 1,78	24	40

NPT – Anschluß

konisches – Gewinde mit 60° Dichtkegel

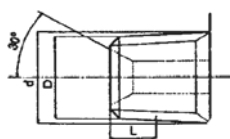

L = Einschraublänge von Hand

Gewinde:	klein $\varnothing D$	groß $\varnothing d$	L	Size
1/8"-27	9,98	10,29	4,5	2
1/4"-18	13,26	13,72	5,1	4
3/8"-18	16,68	17,15	6,1	6
1/2"-14	20,71	21,34	8,1	8
3/4"-14	26,03	26,67	8,6	12
1"-11.1/2	32,59	33,40	10,6	16
1.1/4"-11.1/2	41,31	42,16	10,7	20
1.1/2"-11.1/2	47,39	48,26	10,7	24
2"-11.1/2	59,40	60,33	11,1	32

Metrischer – Anschluß

Rohranschluß mit 24° Dichtkegel DIN2353

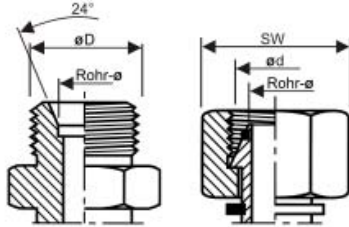

Gewinde:	Außen Ø D	Innen Ø d	Rohr Ø LL	Rohr Ø L	Rohr Ø S	SW	NW
M 8x1	8,0	6,9	4 LL	-	-	10	2,5
M 10x1	10,0	8,9	6 LL	-	-	12	3
M 12x1	12,0	10,9	8 LL	-	-	14	5
M 12x1,5	12,0	10,4	-	6 L	-	14	5
M 14x1,5	14,0	12,4	-	8 L	6 S	17	6 / 4
M 16x1,5	16,0	14,4	-	10 L	8 S	19	8 / 5
M 18x1,5	18,0	16,4	-	12 L	10 S	22	10 / 6
M 20x1,5	20,0	18,4	-	-	12 S	24	8
M 22x1,5	22,0	20,4	-	15 L	14 S	27	13 / 10
M 24x1,5	24,0	22,4	-	-	16 S	30	13
M 26x1,5	26,0	24,4	-	18 L	-	32	16
M 30x2	30,0	27,8	-	22 L	20 S	36	19 / 16
M 36x2	36,0	33,8	-	28 L	25 S	41/46	25 / 19
M 42x2	42,0	39,8	-	-	30 S	50	25
M 45x2	45,0	42,8	-	35 L	-	50	31
M 52x2	52,0	49,8	-	42 L	38 S	60	38

SAE – Anschluß

Flanschanschluß 3000 PSI / 6000PSI

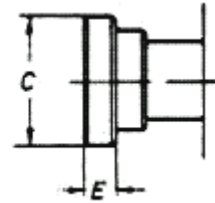
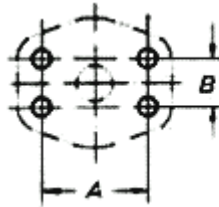

Flansch Nenngröße	3000 PSI				6000 PSI				NW
	A	B	C	E	A	B	C	E	
1/2"	38,1	17,5	30,2	6,7	40,5	18,2	31,8	7,8	13
3/4"	47,6	22,2	38,1	6,7	50,8	23,8	41,3	8,8	19
1"	52,4	26,2	44,5	8,0	57,2	27,8	47,6	9,5	25
1.1/4"	58,7	30,2	50,8	8,0	66,7	31,8	54,0	10,3	31
1.1/2"	69,9	35,7	60,8	8,0	79,4	36,5	63,5	12,6	38
2"	77,8	42,9	71,4	9,5	69,8	44,5	79,4	12,6	50
2.1/2"	88,9	50,8	84,1	9,5					
3"	106,4	61,9	101,6	9,5					
3.1/2"	120,7	69,9	114,3	11,2					

Änderungen vorbehalten! Andere Abmessungen + Ausführungen auf Anfrage.

JIC - Verschraubungen Gerade Verbindung AG-AG

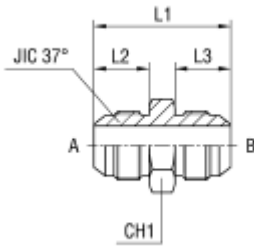

Gewinde E	Gewinde B	Art.-Nr.:
7/16-20UNF	7/16-20UNF	A 07JM-07JM
7/16-20UNF	9/16-20UNF	A 07JM-09JM
1/2-20UNF	1/2-20UNF	A 08JM-08JM
1/2-20UNF	9/16-18UNF	A 08JM-09JM
1/2-20UNF	7/8-14UNF	A 08JM-14JM
9/16-18UNF	9/16-18UNF	A 09JM-09JM
9/16-18UNF	3/4-16UNF	A 09JM-12JM
3/4-16UNF	3/4-16UNF	A 12JM-12JM
3/4-16UNF	7/8-14UNF	A 12JM-14JM
3/4-16UNF	11/16-12UNF	A 12JM-17JM
7/8-14UNF	7/8-14UNF	A 14JM-14JM
7/8-14UNF	11/16-12UNF	A 14JM-17JM
11/16-12UNF	11/16-12UNF	A 17JM-17JM
11/16-12UNF	15/16-12UNF	A 17JM-21JM
13/16-12UNF	13/16-12UNF	A 19JM-19JM
13/16-12UNF	15/16-12UNF	A 19JM-21JM
15/16-12UNF	15/16-12UNF	A 21JM-21JM
15/8-12UNF	15/8-12UNF	A 26JM-26JM
17/8-12UNF	17/8-12UNF	A 30JM-30JM
21/2-12UNF	21/2-12UNF	A 40JM-40JM

JIC - Verschraubungen Winkelverschraubung AG-AG 90°

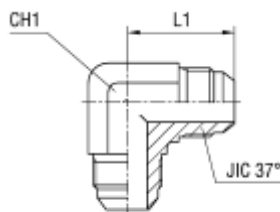

Gewinde A	Gewinde B	Art.-Nr.:
7/16-20UNF	7/16-20UNF	A 07JM-07JM90K
1/2-20UNF	1/2-20UNF	A 08JM-08JM90K
9/16-18UNF	9/16-18UNF	A 09JM-09JM90K
3/4-16UNF	3/4-16UNF	A 12JM-12JM90K
7/8-14UNF	7/8-14UNF	A 14JM-14JM90K
11/16-12UNF	11/16-12UNF	A 17JM-17JM90K
13/16-12UNF	13/16-12UNF	A 19JM-19JM90K
15/16-12UNF	15/16-12UNF	A 21JM-21JM90K
15/8-12UNF	15/8-12UNF	A 26JM-26JM90K

Änderungen vorbehalten! Andere Abmessungen + Ausführungen auf Anfrage.

JIC - Verschraubungen Schottverschraubung AG-AG

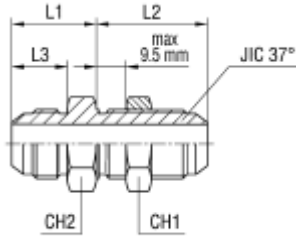

Gewinde A	Gewinde B	Art.-Nr.:
7/16-20UNF	7/16-20UNF	A 07JM-07JMSCHOTT
1/2-20UNF	1/2-20UNF	A 08JM-08JMSCHOTT
9/16-18UNF	9/16-18UNF	A 09JM-09JMSCHOTT
3/4-16UNF	3/4-16UNF	A 12JM-12JMSCHOTT
7/8-14UNF	7/8-14UNF	A 14JM-14JMSCHOTT
11/16-12UNF	11/16-12UNF	A 17JM-17JMSCHOTT
13/16-12UNF	13/16-12UNF	A 19JM-19JMSCHOTT
15/16-12UNF	15/16-12UNF	A 21JM-21JMSCHOTT

JIC - Verschraubungen Winkel – Schottverschraubung AG-AG 90°

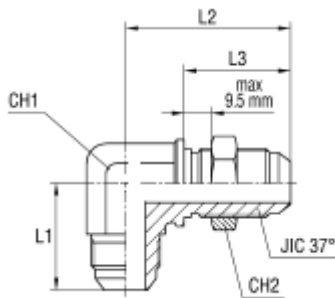

Gewinde A	Gewinde B	Art.-Nr.:
7/16-20UNF	7/16-20UNF	A 07JM-07JMSCHOTT90K
1/2-20UNF	1/2-20UNF	A 08JM-08JMSCHOTT90K
9/16-18UNF	9/16-18UNF	A 09JM-09JMSCHOTT90K
3/4-16UNF	3/4-16UNF	A 12JM-12JMSCHOTT90K
7/8-14UNF	7/8-14UNF	A 14JM-14JMSCHOTT90K
11/16-12UNF	11/16-12UNF	A 17JM-17JMSCHOTT90K
13/16-12UNF	13/16-12UNF	A 19JM-19JMSCHOTT90K
15/16-12UNF	15/16-12UNF	A 21JM-21JMSCHOTT90K

JIC - Verschraubungen T – Verschraubung AG-AG-AG

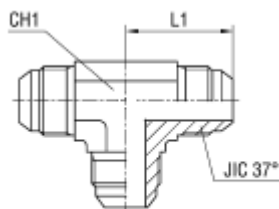

Gewinde A	Gewinde B	Gewinde C	Art.-Nr.:
7/16-20UNF	7/16-20UNF	7/16-20UNF	A 07JM-07JM-07JM
1/2-20UNF	1/2-20UNF	1/2-20UNF	A 08JM-08JM-08JM
9/16-18UNF	9/16-18UNF	9/16-18UNF	A 09JM-09JM-09JM
3/4-16UNF	3/4-16UNF	3/4-16UNF	A 12JM-12JM-12JM
7/8-14UNF	7/8-14UNF	7/8-14UNF	A 14JM-14JM-14JM
11/16-12UNF	11/16-12UNF	11/16-12UNF	A 17JM-17JM-17JM
13/16-12UNF	13/16-12UNF	13/16-12UNF	A 19JM-19JM-19JM
15/16-12UNF	15/16-12UNF	15/16-12UNF	A 21JM-21JM-21JM
15/8-12UNF	15/8-12UNF	15/8-12UNF	A 26JM-26JM-26JM

Änderungen vorbehalten! Andere Abmessungen + Ausführungen auf Anfrage.

JIC - Verschraubungen Gerade Verbindung AG-ÜWM

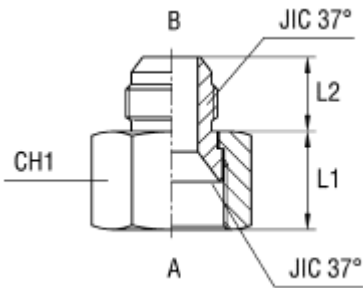

Gewinde A	Gewinde B	Art.-Nr.:
7/16-20UNF	7/16-20UNF	A 07JM-07JF
9/16-18UNF	7/16-20UNF	A 07JM-09JF
3/4-16UNF	7/16-20UNF	A 07JM-12JF
7/8-14UNF	7/16-20UNF	A 07JM-14JF
1/2-20UNF	1/2-20UNF	A 08JM-08JF
9/16-18UNF	9/16-18UNF	A 09JM-09JF
3/4-16UNF	9/16-18UNF	A 09JM-12JF
7/8-14UNF	9/16-18UNF	A 09JM-14JF
11/16-12UNF	9/16-18UNF	A 09JM-17JF
3/4-16UNF	3/4-16UNF	A 12JM-12JF
7/8-14UNF	3/4-16UNF	A 12JM-14JF
11/16-12UNF	3/4-16UNF	A 12JM-17JF
7/8-14UNF	7/8-14UNF	A 14JM-14JF
11/16-12UNF	7/8-14UNF	A 14JM-17JF
11/16-12UNF	11/16-12UNF	A 17JM-17JF
15/16-12UNF	11/16-12UNF	A 17JM-21JF
13/16-12UNF	13/16-12UNF	A 19JM-19JF
15/16-12UNF	15/16-12UNF	A 21JM-21JF
15/8-12UNF	15/16-12UNF	A 21JM-26JF
15/8-12UNF	15/8-12UNF	A 26JM-26JF
17/8-12UNF	17/8-12UNF	A 30JM-30JF

JIC - Verschraubungen Winkelverschraubung AG-ÜWM 45°

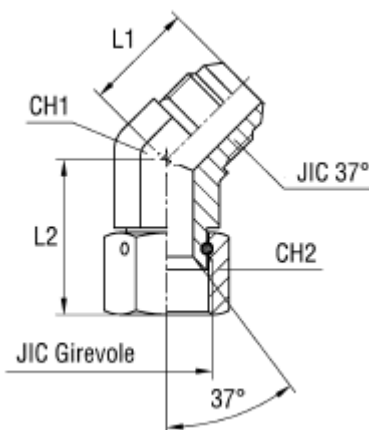

Gewinde A	Gewinde B	Art.-Nr.:
7/16-20UNF	7/16-20UNF	A 07JM-07JF45K
1/2-20UNF	1/2-20UNF	A 08JM-08JF45K
9/16-18UNF	9/16-18UNF	A 09JM-09JF45K
3/4-16UNF	3/4-16UNF	A 12JM-12JF45K
7/8-14UNF	7/8-14UNF	A 14JM-14JF45K
11/16-12UNF	11/16-12UNF	A 17JM-17JF45K
13/16-12UNF	13/16-12UNF	A 19JM-19JF45K
15/16-12UNF	15/16-12UNF	A 21JM-21JF45K
15/8-12UNF	15/8-12UNF	A 26JM-26JF45K

Änderungen vorbehalten! Andere Abmessungen + Ausführungen auf Anfrage.

JIC - Verschraubungen Winkelverschraubung AG-ÜWM 90°

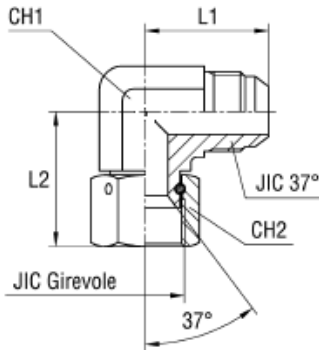

Gewinde A	Gewinde B	Art.-Nr.:
7/16-20UNF	7/16-20UNF	A 07JM-07JF90K
1/2-20UNF	1/2-20UNF	A 08JM-08JF90K
9/16-18UNF	9/16-18UNF	A 09JM-09JF90K
3/4-16UNF	3/4-16UNF	A 12JM-12JF90K
7/8-14UNF	7/8-14UNF	A 14JM-14JF90K
11/16-12UNF	11/16-12UNF	A 17JM-17JF90K
13/16-12UNF	13/16-12UNF	A 19JM-19JF90K
15/16-12UNF	15/16-12UNF	A 21JM-21JF90K
15/8-12UNF	15/8-12UNF	A 26JM-26JF90K

JIC - Verschraubungen T – Verschraubung AG-ÜWM-AG

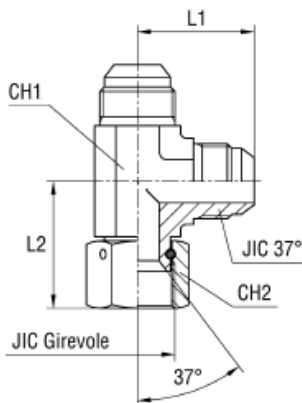

Gewinde A	Gewinde B	Gewinde C	Art.-Nr.:
7/16-20UNF	7/16-20UNF	7/16-20UNF	A 07JM-07JF-07JM
1/2-20UNF	1/2-20UNF	1/2-20UNF	A 08JM-08JF-08JM
9/16-18UNF	9/16-18UNF	9/16-18UNF	A 09JM-09JF-09JM
3/4-16UNF	3/4-16UNF	3/4-16UNF	A 12JM-12JF-12JM
7/8-14UNF	7/8-14UNF	7/8-14UNF	A 14JM-14JF-14JM
11/16-12UNF	11/16-12UNF	11/16-12UNF	A 17JM-17JF-17JM
13/16-12UNF	13/16-12UNF	13/16-12UNF	A 19JM-19JF-19JM
15/16-12UNF	15/16-12UNF	15/16-12UNF	A 21JM-21JF-21JM
15/8-12UNF	15/8-12UNF	15/8-12UNF	A 26JM-26JF-26JM

JIC - Verschraubungen T – Verschraubung AG-AG-ÜWM

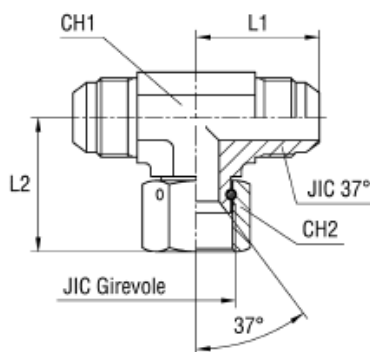

Gewinde A	Gewinde B	Gewinde C	Art.-Nr.:
1/2-20UNF	1/2-20UNF	1/2-20UNF	A 08JM-08JM-08JF
9/16-18UNF	9/16-18UNF	9/16-18UNF	A 09JM-09JM-09JF
3/4-16UNF	3/4-16UNF	3/4-16UNF	A 12JM-12JM-12JF
7/8-14UNF	7/8-14UNF	7/8-14UNF	A 14JM-14JM-14JF
11/16-12UNF	11/16-12UNF	11/16-12UNF	A 17JM-17JM-17JF
15/16-12UNF	15/16-12UNF	15/16-12UNF	A 21JM-21JM-21JF
15/8-12UNF	15/8-12UNF	15/8-12UNF	A 26JM-26JM-26JF

Änderungen vorbehalten! Andere Abmessungen + Ausführungen auf Anfrage.

JIC - Verschraubungen Gerade Verschraubung ÜWM-ÜWM

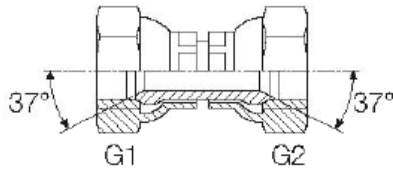

Gewinde 1	Gewinde 2	Art.-Nr.:
7/16-20UNF	7/16-20UNF	A 07JF-07JF
1/2-20UNF	1/2-20UNF	A 08JF-08JF
9/16-18UNF	9/16-18UNF	A 09JF-09JF
3/4-16UNF	3/4-16UNF	A 12JF-12JF
7/8-14UNF	7/8-14UNF	A 14JF-14JF
11/16-12UNF	11/16-12UNF	A 17JF-17JF
13/16-12UNF	13/16-12UNF	A 19JF-19JF

Änderungen vorbehalten! Andere Abmessungen + Ausführungen auf Anfrage.

JIC – NPT Adapter Gerade Verbindung AG-AG

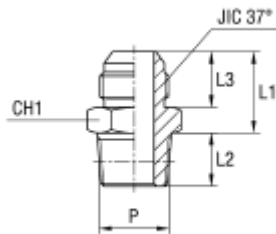

Gewinde - JIC	Gewinde P	Art.-Nr.:
7/16-20UNF	1/8-27NPT	A 07JM-02NM
7/16-20UNF	1/4-18NPT	A 07JM-04NM
7/16-20UNF	3/8-18NPT	A 07JM-06NM
7/16-20UNF	1/2-14NPT	A 07JM-08NM
1/2-20UNF	1/8-27NPT	A 08JM-02NM
1/2-20UNF	1/4-18NPT	A 08JM-04NM
1/2-20UNF	3/8-18NPT	A 08JM-06NM
9/16-18UNF	1/8-27NPT	A 09JM-02NM
9/16-18UNF	1/4-18NPT	A 09JM-04NM
9/16-18UNF	3/8-18NPT	A 09JM-06NM
9/16-18UNF	1/2-14NPT	A 09JM-08NM
3/4-16UNF	1/4-18NPT	A 12JM-04NM
3/4-16UNF	3/8-18NPT	A 12JM-06NM
3/4-16UNF	1/2-14NPT	A 12JM-08NM
3/4-16UNF	3/4-14NPT	A 12JM-12NM
7/8-14UNF	3/8-18NPT	A 14JM-06NM
7/8-14UNF	1/2-14NPT	A 14JM-08NM
7/8-14UNF	3/4-14NPT	A 14JM-12NM
7/8-14UNF	1-11,5NPT	A 14JM-16NM
11/16-12UNF	1/2-14NPT	A 17JM-08NM
11/16-12UNF	3/4-14NPT	A 17JM-12NM
11/16-12UNF	1-11,5NPT	A 17JM-16NM
15/16-12UNF	3/4-14NPT	A 21JM-12NM
15/16-12UNF	1-11,5NPT	A 21JM-16NM
15/16-12UNF	11/4-11,5NPT	A 21JM-20NM
15/8-12UNF	1-11,5NPT	A 26JM-16NM
15/8-12UNF	11/4-11,5NPT	A 26JM-20NM
17/8-12UNF	11/4-11,5NPT	A 30JM-20NM

Änderungen vorbehalten! Andere Abmessungen + Ausführungen auf Anfrage.

JIC – NPT Adapter Winkelverschraubung AG-AG 45°

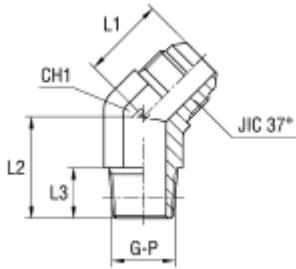

Gewinde - JIC	Gewinde P	Art.-Nr.:
7/16-20UNF	1/8-27NPT	A 07JM-02NM45K
7/16-20UNF	1/4-18NPT	A 07JM-04NM45K
1/2-20UNF	1/8-27NPT	A 08JM-02NM45K
1/2-20UNF	1/4-18NPT	A 08JM-04NM45K
9/16-18UNF	1/4-18NPT	A 09JM-04NM45K
9/16-18UNF	3/8-18NPT	A 09JM-06NM45K
9/16-18UNF	1/2-14NPT	A 09JM-08NM45K
3/4-16UNF	1/4-18NPT	A 12JM-04NM45K
3/4-16UNF	3/8-18NPT	A 12JM-06NM45K
3/4-16UNF	1/2-14NPT	A 12JM-08NM45K
7/8-14UNF	3/8-18NPT	A 14JM-06NM45K
7/8-14UNF	1/2-14NPT	A 14JM-08NM45K
7/8-14UNF	3/4-14NPT	A 14JM-12NM45K
11/16-12UNF	1/2-14NPT	A 17JM-08NM45K
11/16-12UNF	3/4-14NPT	A 17JM-12NM45K
15/16-12UNF	3/4-14NPT	A 21JM-12NM45K
15/16-12UNF	1-11,5NPT	A 21JM-16NM45K

JIC – NPT Adapter Winkelverschraubung AG-AG 90°

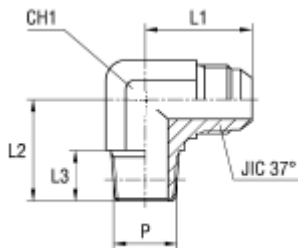

Gewinde - JIC	Gewinde P	Art.-Nr.:
7/16-20UNF	1/8-27NPT	A 07JM-02NM90K
7/16-20UNF	1/4-18NPT	A 07JM-04NM90K
1/2-20UNF	1/8-27NPT	A 08JM-02NM90K
1/2-20UNF	1/4-18NPT	A 08JM-04NM90K
9/16-18UNF	1/4-18NPT	A 09JM-04NM90K
9/16-18UNF	3/8-18NPT	A 09JM-06NM90K
9/16-18UNF	1/2-14NPT	A 09JM-08NM90K
3/4-16UNF	1/4-18NPT	A 12JM-04NM90K
3/4-16UNF	3/8-18NPT	A 12JM-06NM90K
3/4-16UNF	1/2-14NPT	A 12JM-08NM90K
3/4-16UNF	3/4-14NPT	A 12JM-12NM90K
7/8-14UNF	3/8-18NPT	A 14JM-06NM90K
7/8-14UNF	1/2-14NPT	A 14JM-08NM90K
7/8-14UNF	3/4-14NPT	A 14JM-12NM90K
11/16-12UNF	1/2-14NPT	A 17JM-08NM90K
11/16-12UNF	3/4-14NPT	A 17JM-12NM90K
11/16-12UNF	1-11,5NPT	A 17JM-16NM90K
15/16-12UNF	3/4-14NPT	A 21JM-12NM90K
15/16-12UNF	1-11,5NPT	A 21JM-16NM90K
15/8-12UNF	11/4-11,5NPT	A 26JM-20NM90K

Änderungen vorbehalten! Andere Abmessungen + Ausführungen auf Anfrage.

JIC – NPT Adapter T - Verschraubung AG-AG-AG

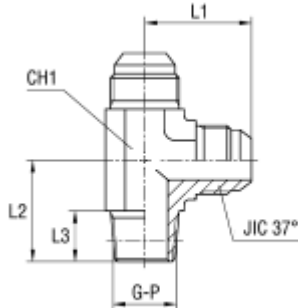

Gewinde 1	Gewinde P	Gewinde 3	Art.-Nr.:
7/16-20UNF	7/16-20UNF	1/8-27NPT	A 07JM-07JM-02NM
1/2-20UNF	1/2-20UNF	1/8-27NPT	A 08JM-08JM-02NM
9/16-18UNF	9/16-18UNF	1/4-18NPT	A 09JM-09JM-04NM
3/4-16UNF	3/4-16UNF	3/8-18NPT	A 12JM-12JM-06NM
7/8-14UNF	7/8-14UNF	1/2-14NPT	A 14JM-14JM-08NM
11/16-12UNF	11/16-12UNF	3/4-14NPT	A 17JM-17JM-12NM
15/16-12UNF	15/16-12UNF	1-11,5NPT	A 21JM-21JM-16NM

JIC – NPT Adapter T - Verschraubung AG-AG-AG

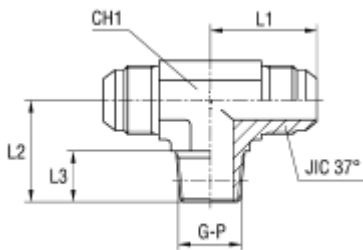

Gewinde 1	Gewinde P	Gewinde 3	Art.-Nr.:
7/16-20UNF	1/8-27NPT	7/16-20UNF	A 07JM-02NM-07JM
1/2-20UNF	1/8-27NPT	1/2-20UNF	A 08JM-02NM-08JM
9/16-18UNF	1/4-18NPT	9/16-18UNF	A 09JM-04NM-09JM
3/4-16UNF	3/8-18NPT	3/4-16UNF	A 12JM-06NM-12JM
7/8-14UNF	1/2-14NPT	7/8-14UNF	A 14JM-08NM-14JM
11/16-12UNF	3/4-14NPT	11/16-12UNF	A 17JM-12NM-17JM

JIC – NPT Adapter Gerade Verschraubung AG-IG

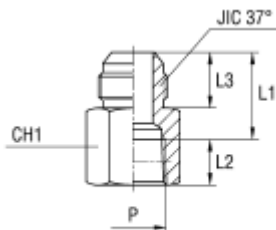

Gewinde - JIC	Gewinde P	Art.-Nr.:
7/16-20UNF	1/8-27NPT	A 07JM-02NMF
9/16-18UNF	1/4-18NPT	A 09JM-04NMF
3/4-16UNF	3/8-18NPT	A 12JM-06NMF
3/4-16UNF	1/2-14NPT	A 12JM-08NMF
7/8-14UNF	1/2-14NPT	A 14JM-08NMF
11/16-12UNF	3/4-14NPT	A 17JM-12NMF
15/16-12UNF	1-11,5NPT	A 21JM-16NMF
15/8-12UNF	11/4-11,5NPT	A 26JM-20NMF

Änderungen vorbehalten! Andere Abmessungen + Ausführungen auf Anfrage.

JIC – NPT Adapter Winkelverschraubung AG-IG 90°

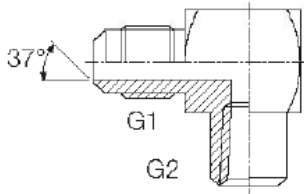

Gewinde 1	Gewinde 2	Art.-Nr.:
7/16-20UNF	1/8-27NPT	A 07JM-02NMF90K
9/16-18UNF	3/8-18NPT	A 09JM-06NMF90K
3/4-16UNF	3/8-18NPT	A 12JM-06NMF90K
11/16-12UNF	3/4-14NPT	A 17JM-12NMF90K
13/16-12UNF	3/4-14NPT	A 19JM-12NMF90K

JIC – Metrisch Gerade Einschraubverschraubung AG-AG

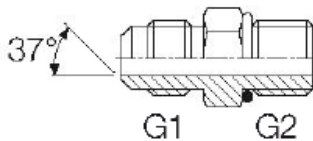

Gewinde 1	Gewinde 2	Art.-Nr.:
7/16-20UNF	M10x1,0	A 07JM-10MO
7/16-20UNF	M12x1,5	A 07JM-12MO
7/16-20UNF	M14x1,5	A 07JM-14MO
1/2-20UNF	M12x1,5	A 08JM-12MO
9/16-18UNF	M14x1,5	A 09JM-14MO
9/16-18UNF	M16x1,5	A 09JM-16MO
3/4-16UNF	M16x1,5	A 12JM-16MO
3/4-16UNF	M18x1,5	A 12JM-18MO
3/4-16UNF	M22x1,5	A 12JM-22MO
7/8-14UNF	M18x1,5	A 14JM-18MO
7/8-14UNF	M20x1,5	A 14JM-20MO
7/8-14UNF	M22x1,5	A 14JM-22MO
11/16-12UNF	M22x1,5	A 17JM-22MO
11/16-12UNF	M27x2,0	A 17JM-27MO
15/16-12UNF	M33x2,0	A 21JM-33MO

JIC – Metrisch Winkeleinschraubverschraubung AG-AG 90°

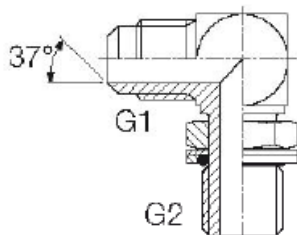

Gewinde 1	Gewinde 2	Art.-Nr.:
7/16-20UNF	M10x1,0	A 07JM-10MO90F
7/16-20UNF	M12x1,5	A 07JM-12MO90F
1/2-20UNF	M12x1,5	A 08JM-12MO90F
9/16-18UNF	M14x1,5	A 09JM-14MO90F
3/4-16UNF	M16x1,5	A 12JM-16MO90F
3/4-16UNF	M18x1,5	A 12JM-18MO90F
3/4-16UNF	M22x1,5	A 12JM-22MO90F
7/8-14UNF	M18x1,5	A 14JM-18MO90F
7/8-14UNF	M22x1,5	A 14JM-22MO90F
11/16-12UNF	M22x1,5	A 17JM-22MO90F
11/16-12UNF	M27x2,0	A 17JM-27MO90F

Änderungen vorbehalten! Andere Abmessungen + Ausführungen auf Anfrage.

JIC – BSP Adapter Gerade Einschraubverschraubung AG-AG mit ORING und Unterlegscheibe

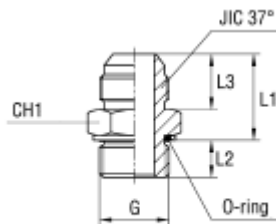

Gewinde - JIC	Gewinde G	Art.-Nr.:
7/16-20UNF	1/8"	A 07JM-02BO
7/16-20UNF	1/4"	A 07JM-04BO
7/16-20UNF	3/8"	A 07JM-06BO
7/16-20UNF	1/2"	A 07JM-08BO
1/2-20UNF	1/4"	A 08JM-04BO
1/2-20UNF	3/8"	A 08JM-06BO
9/16-18UNF	1/4"	A 09JM-04BO
9/16-18UNF	3/8"	A 09JM-06BO
9/16-18UNF	1/2"	A 09JM-08BO
3/4-16UNF	1/4"	A 12JM-04BO
3/4-16UNF	3/8"	A 12JM-06BO
3/4-16UNF	1/2"	A 12JM-08BO
3/4-16UNF	3/4"	A 12JM-12BO
7/8-14UNF	3/8"	A 14JM-06BO
7/8-14UNF	1/2"	A 14JM-08BO
7/8-14UNF	3/4"	A 14JM-12BO
11/16-12UNF	3/8"	A 17JM-06BO
11/16-12UNF	1/2"	A 17JM-08BO
11/16-12UNF	3/4"	A 17JM-12BO
11/16-12UNF	1"	A 17JM-16BO
15/16-12UNF	3/4"	A 21JM-12BO
15/16-12UNF	1"	A 21JM-16BI
15/16-12UNF	1 1/4"	A 21JM-20BO
15/8-12UNF	1"	A 26JM-16BO
15/8-12UNF	1 1/4"	A 26JM-20BO
17/8-12UNF	1 1/4"	A 30JM-20BO
17/8-12UNF	1 1/2"	A 30JM-24BO

JIC – BSP Adapter Winkel Einschraubverschraubung AG-AG 45° mit ORING und Unterlegscheibe

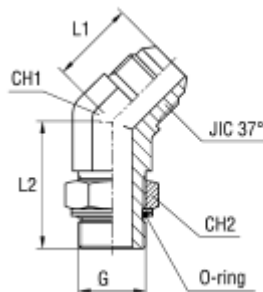

Gewinde - JIC	Gewinde G	Art.-Nr.:
7/16-20UNF	1/4"	A 07JM-04BO45f
1/2-20UNF	1/4"	A 08JM-04BO45F
9/16-18UNF	1/4"	A 09JM-04BO45F
3/4-16UNF	3/8"	A 12JM-06BO45F
3/4-16UNF	1/2"	A 12JM-08BO45F
7/8-14UNF	1/2"	A 14JM-08BO45F
11/16-12UNF	1/2"	A 17JM-08BO45F
11/16-12UNF	3/4"	A 17JM-12BO45F
15/16-12UNF	1"	A 21JM-16BO45F
15/8-12UNF	1 1/4"	A 26JM-20BO45F
17/8-12UNF	1 1/2"	A 30JM-24BO45F

Änderungen vorbehalten! Andere Abmessungen + Ausführungen auf Anfrage.

JIC – BSP Adapter

Winkel Einschraubverschraubung AG-AG 90°

einstellbar, mit ORING und Unterlegscheibe

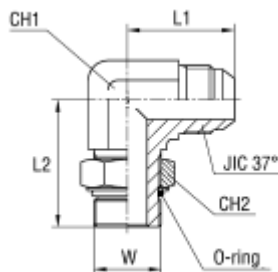

Gewinde 1	Gewinde 2	Art.-Nr.:
7/16-20UNF	1/8"	A 07JM-02BO90F
7/16-20UNF	1/4"	A 07JM-04BO90F
7/16-20UNF	3/8"	A 07JM-06BO90F
7/16-20UNF	1/2"	A 07JM-08BO90F
1/2-20UNF	1/4"	A 08JM-04BO90F
1/2-20UNF	3/8"	A 08JM-06BO90F
9/16-18UNF	1/4"	A 09JM-04BO90F
9/16-18UNF	3/8"	A 09JM-06BO90F
9/16-18UNF	1/2"	A 09JM-08BO90F
3/4-16UNF	1/4"	A 12JM-04BO90F
3/4-16UNF	3/8"	A 12JM-06BO90F
3/4-16UNF	1/2"	A 12JM-08BO90F
3/4-16UNF	3/4"	A 12JM-12BO90F
7/8-14UNF	3/8"	A 14JM-06BO90F
7/8-14UNF	1/2"	A 14JM-08BO90F
7/8-14UNF	3/4"	A 14JM-12BO90F
11/16-12UNF	1/2"	A 17JM-08BO90F
11/16-12UNF	3/4"	A 17JM-12BO90F
11/16-12UNF	1"	A 17JM-16BO90F
15/16-12UNF	3/4"	A 21JM-12BO90F
15/16-12UNF	1"	A 21JM-16BO90F
15/8-12UNF	1"	A 26JM-16BO90F
15/8-12UNF	1 1/4"	A 26JM-20BO90F
17/8-12UNF	1 1/2"	A 30JM-24BO90F

Änderungen vorbehalten! Andere Abmessungen + Ausführungen auf Anfrage.

JIC – BSP Adapter
T – Einschraubverschraubung AG-AG-AG
einstellbar, mit ORING und Unterlegscheibe

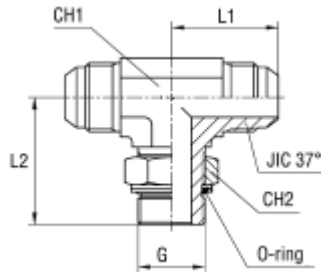

Gewinde A	Gewinde B	Gewinde G	Art.-Nr.:
7/16-20UNF	7/16-20UNF	G 1/8"	A 07JM-07JM-02BO
9/16-18UNF	9/16-18UNF	G 1/4"	A 09JM-09JM-04BO
3/4-16UNF	3/4-16UNF	G 3/8"	A 12JM-12JM-06BO
7/8-14UNF	7/8-14UNF	G 1/2"	A 14JM-14JM-08BO
11/16-12UNF	11/16-12UNF	G 3/4"	A 17JM-17JM-12BO
15/16-12UNF	15/16-12UNF	G 1"	A 21JM-21JM-16BO
17/8-12UNF	17/8-12UNF	G1 1/2"	A 30JM-30JM-24BO

JIC – BSP Adapter
L – Einschraubverschraubung AG-AG-AG
einstellbar, mit ORING und Unterlegscheibe

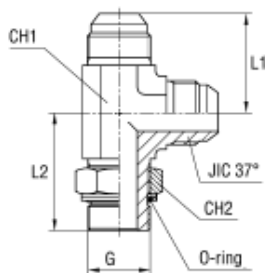

Gewinde A	Gewinde G	Gewinde B	Art.-Nr.:
7/16-20UNF	G 1/8"	7/16-20UNF	A 07JM-02BO-07JM
9/16-18UNF	G 1/4"	9/16-18UNF	A 09JM-04BO-09JM
3/4-16UNF	G 3/8"	3/4-16UNF	A 12JM-06BO-12JM
7/8-14UNF	G 1/2"	7/8-14UNF	A 14JM-08BO-14JM
11/16-12UNF	G 3/4"	11/16-12UNF	A 17JM-12BO-17JM
15/16-12UNF	G 1"	15/16-12UNF	A 21JM-16BO-21JM
17/8-12UNF	G1 1/2"	17/8-12UNF	A 30JM-24BO-30JM

Änderungen vorbehalten! Andere Abmessungen + Ausführungen auf Anfrage.

JIC – Verschlussschraube

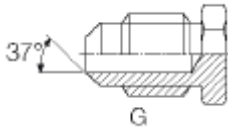

Gewinde A	Art.-Nr.:
7/16-20UNF	A 07JM-V
1/2"-20UNF	A08JM-V
9/16-18UNF	A 09JM-V
3/4-16UNF	A 12JM-V
7/8-14UNF	A 14JM-V
11/16-12UNF	A 17JM-V
13/16-12UNF	A19JM-V
15/16-12UNF	A 21JM-V
15/8-12UNF	A 26JM-V

JIC – Verschlusskappe

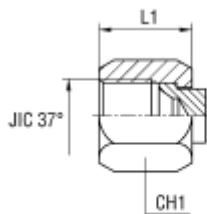

Gewinde A	Art.-Nr.:
7/16-20UNF	A 07JF-V
1/2"-20UNF	A08JF-V
9/16-18UNF	A 09JF-V
3/4-16UNF	A 12JF-V
7/8-14UNF	A 14JF-V
11/16-12UNF	A 17JF-V
13/16-12UNF	A19JF-V
15/16-12UNF	A 21JF-V
15/8-12UNF	A 26JF-V

Änderungen vorbehalten! Andere Abmessungen + Ausführungen auf Anfrage.

BSP - Verschraubungen Gerade Verbindung AG-AG

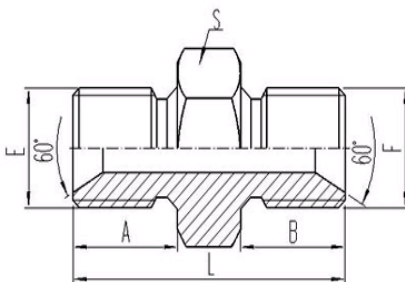

Gewinde E	Gewinde F	Art.-Nr.:
1/8"	1/8"	A 02BM-02BM
1/8"	1/4"	A 02BM-04BM
1/8"	3/8"	A 02BM-06BM
1/8"	1/2"	A 02BM-08BM
1/4"	1/4"	A 04BM-04BM
1/4"	3/8"	A 04BM-06BM
1/4"	1/2"	A 04BM-08BM
1/4"	3/4"	A 04BM-12BM
3/8"	3/8"	A 06BM-06BM
3/8"	1/2"	A 06BM-08BM
3/8"	5/8"	A 06BM-10BM
3/8"	3/4"	A 06BM-12BM
3/8"	1"	A 06BM-16BM
1/2"	1/2"	A 08BM-08BM
1/2"	5/8"	A 08BM-10BM
1/2"	3/4"	A 08BM-12BM
1/2"	1"	A 08BM-16BM
5/8"	5/8"	A 18BM-10BM
5/8"	3/4"	A 10BM-12BM
5/8"	1"	A 10BM-16BM
3/4"	3/4"	A 12BM-12BM
3/4"	1"	A 12BM-16BM
3/4"	1 1/4"	A 12BM-20BM
1"	1"	A 16BM-16BM
1"	1 1/4"	A 16BM-20BM
1"	1 1/2"	A 16BM-24BM
1 1/4"	1 1/4"	A 20BM-20BM
1 1/4"	1 1/2"	A 20BM-24BM
1 1/4"	2"	A 20BM-32BM
1 1/2"	1 1/2"	A 24BM-24BM
1 1/2"	2"	A 24BM-32BM
2"	2"	A 32BM-32BM
2 1/2"	2 1/2"	A 40BM-40BM

Änderungen vorbehalten! Andere Abmessungen + Ausführungen auf Anfrage.

BSP - Verschraubungen Gerade Verbindung ÜWM-ÜWM

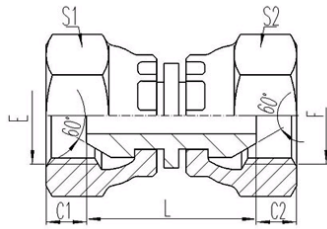

Gewinde E	Gewinde F	Art.-Nr.:
1/8"	1/8"	A 02BF-02BF
1/4"	1/4"	A 04BF-04BF
1/4"	3/8"	A 04BF-06BF
1/4"	1/2"	A 04BF-08BF
3/8"	3/8"	A 06BF-06BF
3/8"	1/2"	A 06BF-08BF
1/2"	1/2"	A 08BF-08BF
1/2"	5/8"	A 08BF-10BF
1/2"	3/4"	A 08BF-12BF
5/8"	5/8"	A 18BF-10BF
3/4"	3/4"	A 12BF-12BF
3/4"	1"	A 12BF-16BF
1"	1"	A 16BF-16BF
1 1/4"	1 1/4"	A 20BF-20BF
1 1/4"	1 1/2"	A 20BF-24BF
1 1/2"	1 1/2"	A 24BF-24BF

BSP - Verschraubungen Winkel Verschraubung 90° ÜWM-ÜWM

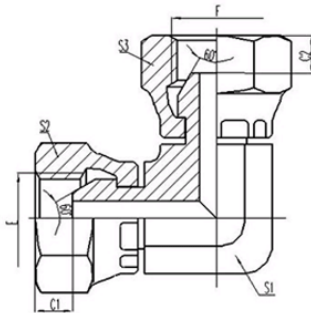

Gewinde E	Gewinde F	Art.-Nr.:
1/4"	1/4"	A 04BF-04BF90F
3/8"	3/8"	A 06BF-06BF90F
1/2"	1/2"	A 08BF-08BF90F
5/8"	5/8"	A 10BF-10BF90F
3/4"	3/4"	A 12BF-12BF90F
1"	1"	A 16BF-16BF90F
1 1/4"	1 1/4"	A 20BF-20BF90F

BSP - Verschraubungen T - Verschraubung ÜWM-ÜWM-ÜWM

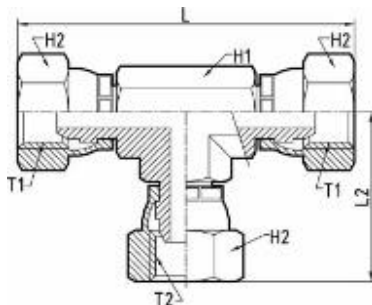

Gewinde T1	Gewinde T2	Gewinde T3	Art.-Nr.:
1/8"	1/8"	1/8"	A 02BF-02BF-02BF
1/4"	1/4"	1/4"	A 04BF-04BF-04BF
3/8"	3/8"	3/8"	A 06BF-06BF-06BF
1/2"	1/2"	1/2"	A 08BF-08BF-08BF
5/8"	5/8"	5/8"	A 10BF-10BF-10BF
3/4"	3/4"	3/4"	A 12BF-12BF-12BF
1"	1"	1"	A 16BF-16BF-16BF
1 1/4"	1 1/4"	1 1/4"	A 20BF-20BF-20BF

Änderungen vorbehalten! Andere Abmessungen + Ausführungen auf Anfrage.

BSP - Verschraubungen Gerade Schottverschraubung AG-AG

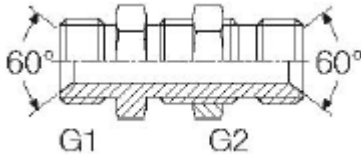

Gewinde 1	Gewinde 2	Art.-Nr.:
1/8"	1/8"	A 02BM-SCHOTT02BM
1/4"	1/4"	A 04BM-SCHOTT04BM
3/8"	3/8"	A 06BM-SCHOTT06BM
1/2"	1/2"	A 08BM-SCHOTT08BM
5/8"	5/8"	A 18BM-SCHOTT10BM
3/4"	3/4"	A 12BM-SCHOTT12BM
1"	1"	A 16BM-SCHOTT16BM
1 1/4"	1 1/4"	A 20BM-SCHOTT20BM
1 1/2"	1 1/2"	A 24BM-SCHOTT24BM
2"	2"	A 32BM-SCHOTT32BM

BSP - Verschraubungen Gerade Einschraubverschraubung AG-AG

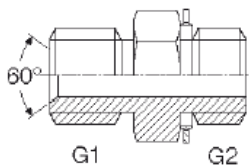

Gewinde 1	Gewinde 2	Art.-Nr.:
1/4"	1/4"	A 04BM-04BMDW
3/8"	3/8"	A 06BM-06BMDW
1/2"	1/2"	A 08BM-08BMDW
5/8"	5/8"	A 10BM-10BMDW
3/4"	3/4"	A 12BM-12BMDW
1"	1"	A 16BM-16BMDW

Änderungen vorbehalten! Andere Abmessungen + Ausführungen auf Anfrage.

BSP - Verschraubungen Gerade Einschraubverschraubung AG-AG kegelig

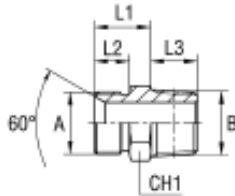

Gewinde A	Gewinde B	Art.-Nr.:
1/4"	1/8"	A 04BM-02BMT
1/4"	1/4"	A 04BM-04BMT
1/4"	3/8"	A 04BM-06BMT
1/4"	1/2"	A 04BM-08BMT
3/8"	1/4"	A 06BM-04BMT
3/8"	3/8"	A 06BM-06BMT
3/8"	1/2"	A 06BM-08BMT
1/2"	3/8"	A 08BM-06BMT
1/2"	1/2"	A 08BM-08BMT
1/2"	3/4"	A 08BM-12BMT
5/8"	1/2"	A 10BM-08BMT
3/4"	3/4"	A 12BM-12BMT
3/4"	1"	A 12BM-16BMT
1"	1"	A 16BM-16BMT
1 1/4"	1"	A 20BM-16BMT
1 1/4"	1 1/4"	A 20BM-20BMT
1 1/2"	1 1/2"	A 24BM-24BMT
2"	2"	A 32BM-32BMT

BSP - Verschraubungen Winkel Einschraubverschraubung 90° AG-AG kegelig

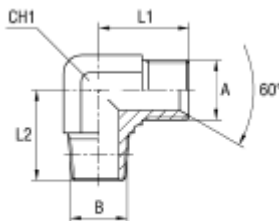

Gewinde A	Gewinde B	Art.-Nr.:
1/4"	1/4"	A 04BM-04BMT90K
3/8"	3/8"	A 06BM-06BMT90K
1/2"	1/2"	A 08BM-08BMT90K

BSP - Verschraubungen Winkel Einschraubverschraubung 90° AG-AG

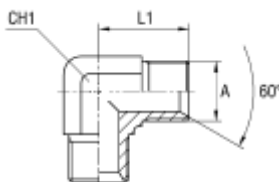

Gewinde A	Gewinde B	Art.-Nr.:
1/4"	1/4"	A 04BM-04BM90F
3/8"	3/8"	A 06BM-06BM90F
3/8"	1/2"	A 06BM-08BM90F
1/2"	3/8"	A 08BM-06BM90F
1/2"	1/2"	A 08BM-08BM90F
5/8"	5/8"	A 10BM-10BM90F
3/4"	3/4"	A 12BM-12BM90F
1"	1"	A 16BM-16BM90F

Änderungen vorbehalten! Andere Abmessungen + Ausführungen auf Anfrage.

BSP - Verschraubungen
Winkel Einschraubverschraubung 45° AG-AG
einstellbar mit ORING und Unterlegscheibe

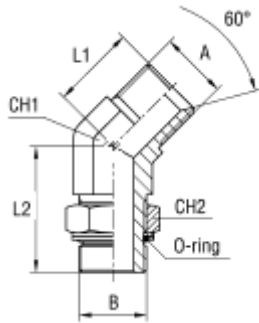

Gewinde A	Gewinde B	Art.-Nr.:
1/4"	1/4"	A 04BM-04BO45F
3/8"	3/8"	A 06BM-06BO45F
1/2"	1/2"	A 08BM-08BO45F
3/4"	3/4"	A 12BM-12BO45F
1"	1"	A 16BM-16BO45F
1 1/4"	1 1/4"	A 20BM-20BO45F
1 1/2"	1 1/2"	A 24BM-24BO45F

BSP - Verschraubungen
Winkel Einschraubverschraubung 90° AG-AG
einstellbar mit ORING und Unterlegscheibe

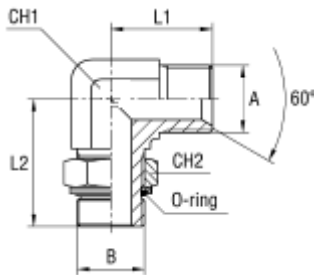

Gewinde A	Gewinde B	Art.-Nr.:
1/4"	1/4"	A 04BM-04BO90F
3/8"	3/8"	A 06BM-06BO90F
1/2"	1/2"	A 08BM-08BO90F
3/4"	3/4"	A 12BM-12BO90F
1"	1"	A 16BM-16BO90F
1 1/4"	1 1/4"	A 20BM-20BO90F
1 1/2"	1 1/2"	A 24BM-24BO90F

BSP - Verschraubungen
T - Verschraubung AG-AG-AG

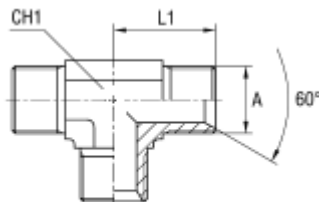

Gewinde A	Gewinde B	Gewinde C	Art.-Nr.:
1/8"	1/8"	1/8"	A 02BM-02BM-02BM
1/4"	1/4"	1/4"	A 04BM-04BM-04BM
3/8"	3/8"	3/8"	A 06BM-06BM-06BM
1/2"	1/2"	1/2"	A 08BM-08BM-08BM
5/8"	5/8"	5/8"	A 10BM-10BM-10BM
3/4"	3/4"	3/4"	A 12BM-12BM-12BM
1"	1"	1"	A 16BM-16BM-16BM

Änderungen vorbehalten! Andere Abmessungen + Ausführungen auf Anfrage.

BSP - Verschraubungen
T - Einschraubverschraubung AG-AG-AG
einstellbar mit ORING und Unterlegscheibe

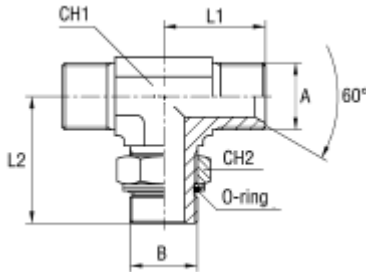

Gewinde A	Gewinde B	Gewinde C	Art.-Nr.:
1/4"	1/4"	1/4"	A 04BM-04BM-04BO
3/8"	3/8"	3/8"	A 06BM-06BM-06BO
1/2"	3/8"	1/2"	A 08BM-08BM-08BO
1/2"	1/2"	1/2"	A 12BM-12BM-08BO
3/4"	3/4"	3/4"	A 12BM-12BM-12BO
1"	3/4"	1"	A 16BM-16BM-12BO
1"	1"	1"	A 16BM-16BM-16BO

BSP - Verschraubungen
T - Einschraubverschraubung AG-AG-AG
einstellbar mit ORING und Unterlegscheibe

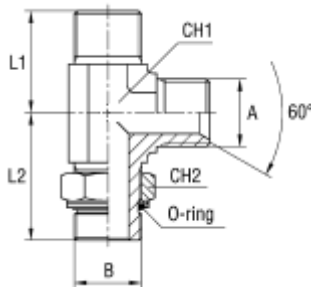

Gewinde A	Gewinde B	Gewinde C	Art.-Nr.:
1/4"	1/4"	1/4"	A 04BM-04BO-04BM
3/8"	1/4"	3/8"	A 06BM-04BO-06BM
3/8"	3/8"	3/8"	A 06BM-06BO-06BM
1/2"	3/8"	1/2"	A 08BM-06BO-08BM
1/2"	1/2"	1/2"	A 08BM-08BO-08BM
3/4"	3/4"	3/4"	A 12BM-12BO-12BM
1"	1"	1"	A 16BM-16BO-16BM

Änderungen vorbehalten! Andere Abmessungen + Ausführungen auf Anfrage.

BSP - Verschraubungen Gerade Verbindung AG-ÜWM

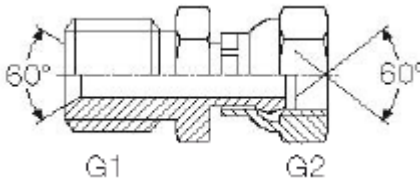

Gewinde 1	Gewinde 2	Art.-Nr.:
1/8"	1/8"	A 02BM-02BF
1/8"	1/4"	A 02BM-04BF
1/4"	1/8"	A 04BM-02BF
1/4"	1/4"	A 04BM-04BF
1/4"	3/8"	A 04BM-06BF
1/4"	1/2"	A 04BM-08BF
3/8"	1/4"	A 06BM-04BF
3/8"	3/8"	A 06BM-06BF
3/8"	1/2"	A 06BM-08BF
1/2"	1/4"	A 08BM-04BF
1/2"	3/8"	A 08BM-06BF
1/2"	1/2"	A 08BM-08BF
1/2"	5/8"	A 08BM-10BF
1/2"	3/4"	A 08BM-12BF
5/8"	1/2"	A 10BM-08BF
5/8"	5/8"	A 10BM-10BF
5/8"	3/4"	A 10BM-12BF
3/4"	1/2"	A 12BM-08BF
3/4"	5/8"	A 12BM-10BF
3/4"	3/4"	A 12BM-12BF
3/4"	1"	A 12BM-16BF
1"	3/4"	A 16BM-12BF
1"	1"	A 16BM-16BF
1"	1 1/4"	A 16BM-20BF
1 1/4"	1 1/4"	A 20BM-20BF
1 1/2"	1 1/2"	A 24BM-24BF
2"	2"	A 32BM-32BF

Änderungen vorbehalten! Andere Abmessungen + Ausführungen auf Anfrage.

BSP - Verschraubungen Winkel Verschraubung 45° AG-ÜWM

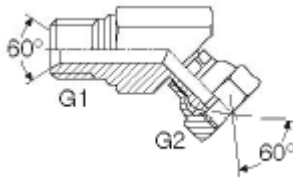

Gewinde 1	Gewinde 2	Art.-Nr.:
1/4"	1/4"	A 04BM-04BO45F
3/8"	3/8"	A 06BM-06BO45F
1/2"	1/2"	A 08BM-08BO45F
3/4"	3/4"	A 12BM-12BO45F
1"	1"	A 16BM-16BO45F
1 1/4"	1 1/4"	A 20BM-20BO45F

BSP - Verschraubungen Winkel Verschraubung 90° AG-ÜWM

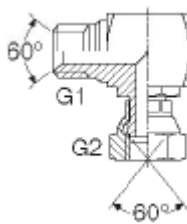

Gewinde 1	Gewinde 2	Art.-Nr.:
1/8	1/8	A 02BM-02BF90F
1/4"	1/4"	A 04BM-04BF90F
3/8"	3/8"	A 06BM-06BF90F
1/2"	1/2"	A 08BM-08BF90F
5/8"	5/8"	A 10BM-10BF90F
3/4"	3/4"	A 12BM-12BF90F
1"	1"	A 16BM-16BF90F
1 1/4"	1 1/4"	A 20BM-20BF90F
1 1/2"	1 1/2"	A 24BM-24BF90F
2"	2"	A 32BM-32BF90F

Änderungen vorbehalten! Andere Abmessungen + Ausführungen auf Anfrage.

BSP - Verschraubungen
T - Verschraubung AG-AG-ÜWM

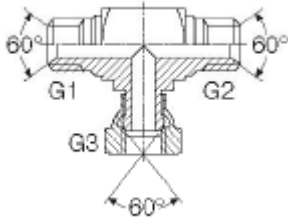

Gewinde A	Gewinde B	Gewinde C	Art.-Nr.:
1/4"	1/4"	1/4"	A 04BM-04BM-04BF
3/8"	3/8"	3/8"	A 06BM-06BM-06BF
1/2"	1/2"	1/2"	A 12BM-12BM-08BF
3/4"	3/4"	3/4"	A 12BM-12BM-12BF
1"	1"	1"	A 16BM-16BM-16BF

BSP - Verschraubungen
T - Verschraubung AG-ÜWM-AG

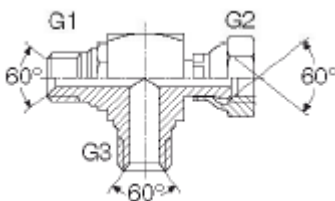

Gewinde A	Gewinde B	Gewinde C	Art.-Nr.:
1/8"	1/8"	1/8"	A 02BM-02BF-02BM
1/4"	1/4"	1/4"	A 04BM-04BF-04BM
3/8"	3/8"	3/8"	A 06BM-06BF-06BM
1/2"	1/2"	1/2"	A 08BM-08BF-08BM
5/8"	5/8"	5/8"	A 10BM-10BF-10BM
3/4"	3/4"	3/4"	A 12BM-12BF-12BM
1"	1"	1"	A 16BM-16BF-16BM
1 1/4"	1 1/4"	1 1/4"	A 20BM-20BF-20BM
2"	2"	2"	A 32BM-32BF-32BM

Änderungen vorbehalten! Andere Abmessungen + Ausführungen auf Anfrage.

BSP - Verschraubungen Verschlußstopfen

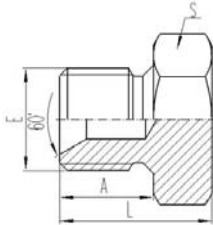

Gewinde E	Art.-Nr.:
1/8"	A 02BM-V
1/4"	A 04BM-V
3/8"	A 06BM-V
1/2"	A 08BM-V
5/8"	A 18BM-V
3/4"	A 12BM-V
1"	A 16BM-V
1 1/4"	A 20BM-V
1 1/2"	A 24BM-V
2"	A 32BM-V

BSP - Verschraubungen Verschlußkappe

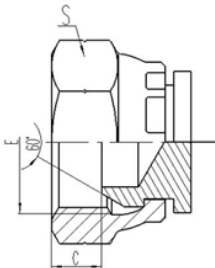

Gewinde E	Art.-Nr.:
1/8"	A 02BF-V
1/4"	A 04BF-V
3/8"	A 06BF-V
1/2"	A 08BF-V
5/8"	A 18BF-V
3/4"	A 12BF-V
1"	A 16BF-V
1 1/4"	A 20BF-V
1 1/2"	A 24BF-V
2"	A 32BF-V

BSP - Verschraubungen Schottmutter

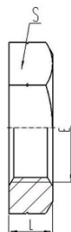

Gewinde E	Art.-Nr.:
1/8"	A 02BSP-SM
1/4"	A 04BSP-SM
3/8"	A 06BSP-SM
1/2"	A 08BSP-SM
5/8"	A 18BSP-SM
3/4"	A 12BSP-SM
1"	A 16BSP-SM
1 1/4"	A 20BSP-SM
1 1/2"	A 24BSP-SM
2"	A 32BSP-SM

Änderungen vorbehalten! Andere Abmessungen + Ausführungen auf Anfrage.

BSP - Verschraubungen
Schott-Einschraubverschraubung BSP-metrisch AG-AG
Einschraubgewinde - weichdichtend

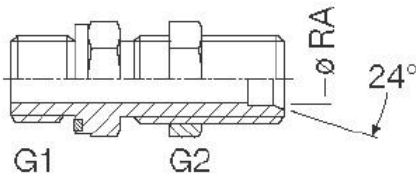

ØRA	Gewinde 1	Gewinde 2	Art.-Nr.:
8L	1/4"	M14x1,5	A 04BED-SCHOTT14ME
8L	3/8"	M14x1,5	A 06BED-SCHOTT14ME
8L	1/2"	M14x1,5	A 08BED-SCHOTT14ME
10L	1/4"	M16x1,5	A 04BED-SCHOTT16ME
10L	1/2"	M16x1,5	A 08BED-SCHOTT16ME
12L	3/8"	M18x1,5	A 06BED-SCHOTT18ME
12L	1/2"	M18x1,5	A 08BED-SCHOTT18ME
15L	1/2"	M22x1,5	A 08BED-SCHOTT22ME
15L	3/4"	M22x1,5	A 12BED-SCHOTT22ME
18L	1/2"	M26x1,5	A 08BED-SCHOTT26ME
18L	3/4"	M26x1,5	A 12BED-SCHOTT26ME
18L	1"	M26x1,5	A 16BED-SCHOTT26ME
22L	3/4"	M30x2	A 12BED-SCHOTT30MEL
42L	1 1/2"	M52x2	A 24BED-SCHOTT52ME
12S	1/2"	M20x1,5	A 08BED-SCHOTT20ME
16S	1/2"	M24x1,5	A 08BED-SCHOTT24ME
16S	3/4"	M24x1,5	A 12BED-SCHOTT24ME
20S	3/4"	M30x2	A 12BED-SCHOTT30MES
25S	3/4"	M36x2	A 12BED-SCHOTT26ME
25S	1"	M36x2	A 16BED-SCHOTT26ME

BSP - Verschraubungen
Schott-Einschraubverschraubung BSP-metrisch AG-AG
Einschraubgewinde – mit Dichtkante

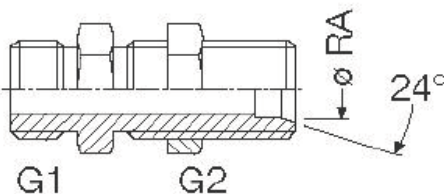

ØRA	Gewinde 1	Gewinde 2	Art.-Nr.:
8L	1/4"	M14x1,5	A 04BB-SCHOTT14ME
8L	3/8"	M14x1,5	A 06BB-SCHOTT14ME
8L	1/2"	M14x1,5	A 08BB-SCHOTT14ME
10L	1/4"	M16x1,5	A 04BB-SCHOTT16ME
10L	1/2"	M16x1,5	A 08BB-SCHOTT16ME
12L	3/8"	M18x1,5	A 06BB-SCHOTT18ME
12L	1/2"	M18x1,5	A 08BB-SCHOTT18ME
15L	1/2"	M22x1,5	A 08BB-SCHOTT22ME
15L	3/4"	M22x1,5	A 12BB-SCHOTT22ME
18L	1/2"	M26x1,5	A 08BB-SCHOTT26ME
18L	3/4"	M26x1,5	A 12BB-SCHOTT26ME
18L	1"	M26x1,5	A 16BB-SCHOTT26ME
22L	3/4"	M30x2	A 12BB-SCHOTT30MEL
42L	1 1/2"	M52x2	A 24BB-SCHOTT52ME
12S	1/2"	M20x1,5	A 08BB-SCHOTT20ME
16S	1/2"	M24x1,5	A 08BB-SCHOTT24ME
16S	3/4"	M24x1,5	A 12BB-SCHOTT24ME
20S	3/4"	M30x2	A 12BB-SCHOTT30MES
25S	3/4"	M36x2	A 12BB-SCHOTT26ME
25S	1"	M36x2	A 16BB-SCHOTT26ME

Änderungen vorbehalten! Andere Abmessungen + Ausführungen auf Anfrage.

BSP - Verschraubungen Gerade Verschraubung BSP-JIC; AG-AG

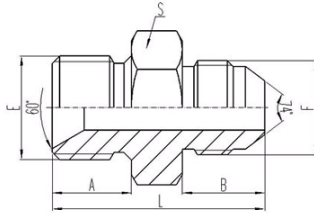

Gewinde E	Gewinde F	Art.-Nr.:
1/4"	7/16-20 UNF	A 04BM-07JM
1/4"	1/2-20 UNF	A 04BM-08JM
1/4"	9/16-18 UNF	A 04BM-09JM
1/4"	3/4-16 UNF	A 04BM-12JM
3/8"	7/16-20 UNF	A 06BM-07JM
3/8"	1/2-20 UNF	A 06BM-08JM
3/8"	9/16-18 UNF	A 06BM-09JM
3/8"	3/4-16 UNF	A 06BM-12JM
3/8"	7/8-14 UNF	A 06BM-14JM
1/2"	7/16-20 UNF	A 08BM-07JM
1/2"	1/2-20 UNF	A 08BM-08JM
1/2"	9/16-18 UNF	A 08BM-09JM
1/2"	3/4-16 UNF	A 08BM-12JM
1/2"	7/8-14 UNF	A 08BM-14JM
1/2"	11/16-12 UNF	A 08BM-17JM
3/4"	3/4-16 UNF	A 12BM-12JM
3/4"	7/8-14 UNF	A 12BM-14JM
3/4"	11/16-12 UNF	A 12BM-17JM
3/4"	13/16-12 UNF	A 12BM-19JM
3/4"	15/16-12 UNF	A 12BM-21JM
1"	15/16-12 UNF	A 16BM-21JM
1 1/2"	2 1/2-12 UNF	A 24BM-40JM
2"	2 1/2-12 UNF	A 32BM-40JM

BSP - Verschraubungen Gerade Verschraubung BSP-JIC; AG-ÜWM

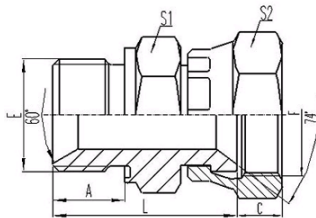

Gewinde E	Gewinde F	Art.-Nr.:
1/8"	7/16-20 UNF	A 02BM-07JF
1/4"	7/16-20 UNF	A 04BM-07JF
1/4"	1/2-20 UNF	A 04BM-08JF
1/4"	9/16-18 UNF	A 04BM-09JF
3/8"	1/2-20 UNF	A 06BM-08JF
3/8"	9/16-18 UNF	A 06BM-09JF
3/8"	3/4-16 UNF	A 06BM-12JF
3/8"	7/8-14 UNF	A 06BM-14JF
1/2"	9/16-18 UNF	A 08BM-09JF
1/2"	3/4-16 UNF	A 08BM-12JF
1/2"	7/8-14 UNF	A 08BM-14JF
5/8"	3/4-16 UNF	A 10BM-12JF
5/8"	7/8-14 UNF	A 10BM-14JF
5/8"	11/16-12 UNF	A 10BM-17JF
3/4"	3/4-16 UNF	A 12BM-12JF
3/4"	7/8-14 UNF	A 12BM-14JF
3/4"	11/16-12 UNF	A 12BM-17JF
3/4"	13/16-12 UNF	A 12BM-19JF
3/4"	15/16-12 UNF	A 12BM-21JF
1"	11/16-12 UNF	A 16BM-17JF
1"	13/16-12 UNF	A 16BM-19JF
1"	15/16-12 UNF	A 16BM-21JF

Änderungen vorbehalten! Andere Abmessungen + Ausführungen auf Anfrage.

BSP - Verschraubungen Gerade Einschraubverschraubung BSP-NPT; AG-AG

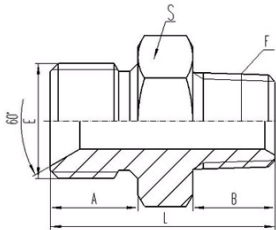

Gewinde E	Gewinde F	Art.-Nr.:
1/8"	1/8-27 NPT	A 02BM-02NM
1/4"	1/8-27 NPT	A 04BM-02NM
1/4"	1/4-18 NPT	A 04BM-04NM
1/4"	3/8-18 NPT	A 04BM-06NM
1/4"	1/2-14 NPT	A 04BM-08NM
3/8"	1/4-18 NPT	A 06BM-04NM
3/8"	3/8-18 NPT	A 06BM-06NM
3/8"	1/2-14 NPT	A 06BM-08NM
1/2"	1/4-18 NPT	A 08BM-04NM
1/2"	3/8-18 NPT	A 08BM-06NM
1/2"	1/2-14 NPT	A 08BM-08NM
1/2"	3/4-14 NPT	A 08BM-12NM
1/2"	1-11,5 NPT	A 08BM-16NM
5/8"	1/2-14 NPT	A 10BM-08NM
3/4"	1/2-14 NPT	A 12BM-08NM
3/4"	3/4-14 NPT	A 12BM-12NM
3/4"	1-11,5 NPT	A 12BM-16NM
1"	1/2-14 NPT	A 16BM-08NM
1"	3/4-14 NPT	A 16BM-12NM
1"	1-11,5 NPT	A 16BM-16NM
1 1/4"	1 1/4-11,5 NPT	A 20BM-20NM
1 1/2"	1 1/2-11,5 NPT	A 24BM-24NM
2"	2-11,5 NPT	A 32BM-32NM
2 1/2"	2 1/2-8 NPT	A 40BM-40NM

BSP - Verschraubungen Winkel Einschraubverschraubung 90°, BSP-NPT; AG-AG

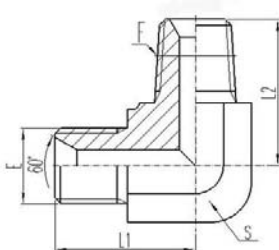

Gewinde E	Gewinde F	Art.-Nr.:
1/4"	1/4-18 NPT	A 04BM-04NM90K
3/8"	3/8-18 NPT	A 06BM-06NM90K
1/2"	1/2-14 NPT	A 08BM-08NM90K
3/4"	3/4-14 NPT	A 12BM-12NM90K

Änderungen vorbehalten! Andere Abmessungen + Ausführungen auf Anfrage.

NPT - Verschraubungen Gerade Verschraubung AG-AG

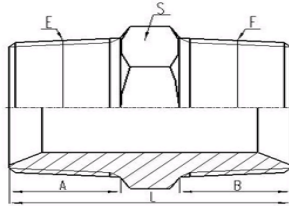

Gewinde E	Gewinde F	Art.-Nr.:
1/8-27 NPT	1/8-27 NPT	Â 02NM-02NM
1/8-27 NPT	1/4-18 NPT	A 02NM-04NM
1/8-27 NPT	3/8-18 NPT	A 02NM-06NM
1/4-18 NPT	1/4-18 NPT	A 04NM-04NM
1/4-18 NPT	3/8-18 NPT	A 04NM-06NM
1/4-18 NPT	1/2-14 NPT	A 04NM-08NM
3/8-18 NPT	3/8-18 NPT	A 06NM-06NM
3/8-18 NPT	1/2-14 NPT	A 06NM-08NM
1/2-14 NPT	1/2-14 NPT	A 08NM-08NM
1/2-14 NPT	3/4-14 NPT	A 08NM-12NM
3/4-14 NPT	3/4-14 NPT	A 12NM-12NM
3/4-14 NPT	1-11,5 NPT	A 12NM-16NM
1-11,5 NPT	1-11,5 NPT	A 16NM-16NM
11/411,5 NPT	11/411,5 NPT	A 20NM-20NM
11/2-11,5 NPT	11/2-11,5 NPT	A 24NM-24NM
2-11,5 NPT	2-11,5 NPT	A 32NM-32NM

NPT - Verschraubungen Winkel Verschraubung 90° AG-AG

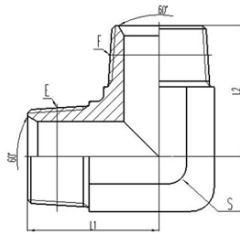

Gewinde E	Gewinde F	Art.-Nr.:
1/4-18 NPT	1/8-27 NPT	A 04NM-02NM90K
1/4-18 NPT	1/4-18 NPT	A 04NM-04NM90K
3/8-18 NPT	3/8-18 NPT	A 06NM-06NM90K
1/2-14 NPT	1/2-14 NPT	A 08NM-08NM90K
3/4-14 NPT	3/4-14 NPT	A 12NM-12NM90K
1-11,5 NPT	1-11,5 NPT	A 16NM-16NM90K

Änderungen vorbehalten! Andere Abmessungen + Ausführungen auf Anfrage.

NPT - Verschraubungen T - Verschraubung AG-AG-AG

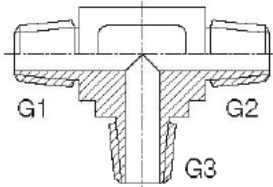

Gewinde 1	Gewinde 2	Gewinde 3	Art.-Nr.:
1/8-27 NPT	1/8-27 NPT	1/8-27 NPT	A 02NM-02NM-02NM
1/4-18 NPT	1/4-18 NPT	1/4-18 NPT	A 04NM-04NM-04NM
3/8-18 NPT	3/8-18 NPT	3/8-18 NPT	A 06NM-06NM-06NM
1/2-14 NPT	1/2-14 NPT	1/2-14 NPT	A 08NM-08NM-08NM
3/4-14 NPT	3/4-14 NPT	3/4-14 NPT	A 12NM-12NM-12NM
1-11,5 NPT	1-11,5 NPT	1-11,5 NPT	A 16NM-16NM-16NM

NPT - Verschraubungen Reduzier und Erweiterungsstutzen AG-IG

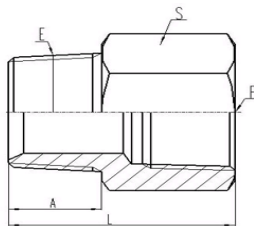

Gewinde E	Gewinde F	Art.-Nr.:
1/8-27 NPT	1/8-27 NPT	Â 02NM-02NMF
1/4-18 NPT	1/4-18 NPT	A 04NM-04NMF
1/4-18 NPT	3/8-18 NPT	A 04NM-06NMF
3/8-18 NPT	3/8-18 NPT	A 06NM-06NMF
3/8-18 NPT	1/2-14 NPT	A 06NM-08NMF
1/2-14 NPT	1/2-14 NPT	A 08NM-08NMF
1/2-14 NPT	3/4-14 NPT	A 08NM-12NMF
3/4-14 NPT	3/4-14 NPT	A 12NM-12NMF
1-11,5 NPT	1-11,5 NPT	A 16NM-16NMF
1 1/4-11,5 NPT	1 1/4-11,5 NPT	A 20NM-20NMF
1 1/2-11,5 NPT	1 1/2-11,5 NPT	A 24NM-24NMF
2-11,5 NPT	2-11,5 NPT	A 32NM-32NMF

NPT - Verschraubungen Winkel Verschraubung 45° AG-IG

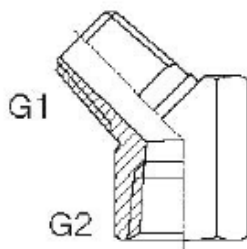

Gewinde 1	Gewinde 2	Art.-Nr.:
1/4-18 NPT	1/4-18 NPT	A 04NM-04NMF45K
3/8-18 NPT	3/8-18 NPT	A 06NM-06NMF45K
1/2-14 NPT	1/2-14 NPT	A 08NM-08NMF45K
3/4-14 NPT	3/4-14 NPT	A 12NM-12NMF45K
1-11,5 NPT	1-11,5 NPT	A 16NM-16NMF45K

Änderungen vorbehalten! Andere Abmessungen + Ausführungen auf Anfrage.

NPT - Verschraubungen Winkel Verschraubung 90° AG-IG

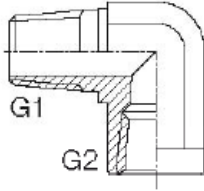

Gewinde 1	Gewinde 2	Art.-Nr.:
1/4-18 NPT	1/4-18 NPT	A 04NM-04NMF90K
3/8-18 NPT	3/8-18 NPT	A 06NM-06NMF90K
1/2-14 NPT	1/2-14 NPT	A 08NM-08NMF90K
3/4-14 NPT	3/4-14 NPT	A 12NM-12NMF90K
1-11,5 NPT	1-11,5 NPT	A 16NM-16NMF90K

NPT - Verschraubungen T - Verschraubung AG-IG-IG

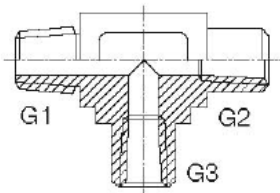

Gewinde 1	Gewinde 2	Gewinde 3	Art.-Nr.:
1/8-27 NPT	1/8-27 NPT	1/8-27 NPT	A 02NM-02NMF-02NMF
1/4-18 NPT	1/4-18 NPT	1/4-18 NPT	A 04NM-04NMF-04NMF
3/8-18 NPT	3/8-18 NPT	3/8-18 NPT	A 06NM-06NMF-06NMF
1/2-14 NPT	1/2-14 NPT	1/2-14 NPT	A 08NM-08NMF-08NMF
3/4-14 NPT	3/4-14 NPT	3/4-14 NPT	A 12NM-12NMF-12NMF
1-11,5 NPT	1-11,5 NPT	1-11,5 NPT	A 16NM-16NMF-16NMF

NPT - Verschraubungen Gewindemuffe IG-IG

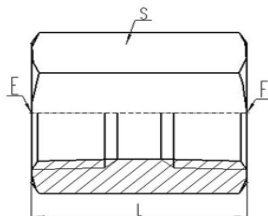

Gewinde E	Gewinde F	Art.-Nr.:
1/8-27 NPT	1/8-27 NPT	Å 02NMF-02NMF
1/4-18 NPT	1/4-18 NPT	A 04NMF-04NMF
1/4-18 NPT	3/8-18 NPT	A 04NMF-06NMF
3/8-18 NPT	3/8-18 NPT	A 06NMF-06NMF
1/2-14 NPT	1/2-14 NPT	A 08NMF-08NMF
1/2-14 NPT	3/4-14 NPT	A 08NMF-12NMF
3/4-14 NPT	3/4-14 NPT	A 12NMF-12NMF
1-11,5 NPT	1-11,5 NPT	A 16NMF-16NMF

Änderungen vorbehalten! Andere Abmessungen + Ausführungen auf Anfrage.

NPT - Verschraubungen Winkel Verschraubung 90° IG-IG

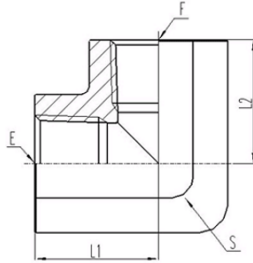

Gewinde E	Gewinde F	Art.-Nr.:
1/8-18 NPT	1/8-27 NPT	A 02NMF-02NMF90K
1/4-18 NPT	1/4-18 NPT	A 04NMF-04NMF90K
3/8-18 NPT	3/8-18 NPT	A 06NMF-06NMF90K
1/2-14 NPT	1/2-14 NPT	A 08NMF-08NMF90K
3/4-14 NPT	3/4-14 NPT	A 12NMF-12NMF90K
1-11,5 NPT	1-11,5 NPT	A 16NMF-16NMF90K

NPT - Verschraubungen T - Verschraubung IG-IG-IG

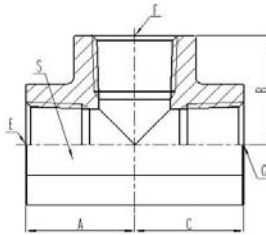

Gewinde E	Gewinde F	Gewinde G	Art.-Nr.:
1/8-27 NPT	1/8-27 NPT	1/8-27 NPT	A 02NMF-02NMF-02NMF
1/4-18 NPT	1/4-18 NPT	1/4-18 NPT	A 04NMF-04NMF-04NMF
3/8-18 NPT	3/8-18 NPT	3/8-18 NPT	A 06NMF-06NMF-06NMF
1/2-14 NPT	1/2-14 NPT	1/2-14 NPT	A 08NMF-08NMF-08NMF
3/4-14 NPT	3/4-14 NPT	3/4-14 NPT	A 12NMF-12NMF-12NMF
1-11,5 NPT	1-11,5 NPT	1-11,5 NPT	A 16NMF-16NMF-16NMF

NPT - Verschraubungen Verschlußschraube AG

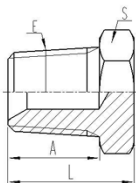

Gewinde E	Art.-Nr.:
1/8-27 NPT	A 04NM-V
1/4-18 NPT	A 04NM-V
3/8-18 NPT	A 06NM-V
1/2-14 NPT	A 08NM-V
3/4-14 NPT	A 12NM-V
1-11,5 NPT	A 16NM-V
11/4-11,5 NPT	A 20NM-V
2-11,5 NPT	A 32NM-V

Änderungen vorbehalten! Andere Abmessungen + Ausführungen auf Anfrage.

ORFS - Verschraubungen Gerade Verbindung AG-AG

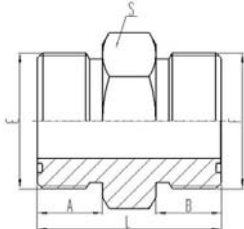

Gewinde E	Gewinde F	Art.-Nr.:
9/16-18 UNF	9/16-18 UNF	A 04ORM-04ORM
9/16-18 UNF	11/16-16 UNF	A 04ORM-06ORM
11/16-16 UNF	11/16-16 UNF	A 06ORM-06ORM
11/16-16 UNF	13/16-16 UNF	A 06ORM-08ORM
13/16-16 UNF	13/16-16 UNF	A 08ORM-08ORM
13/16-16 UNF	1-14 UNF	A 08ORM-10ORM
1-14 UNF	1-14 UNF	A 10ORM-10ORM
1-14 UNF	13/16-12 UNF	A 10ORM-12ORM
13/16-12 UNF	13/16-12 UNF	A 12ORM-12ORM
13/16-12 UNF	17/16-12 UNF	A 12ORM-16ORM
17/16-12 UNF	17/16-12 UNF	A 16ORM-16ORM
17/16-12 UNF	1 11/16-12 UNF	A 16ORM-20ORM
1 11/16-12 UNF	1 11/16-12 UNF	A 20ORM-20ORM
2-12 UNF	2-12 UNF	A 24ORM-24ORM

ORFS - Verschraubungen Gerade Verbindung BSP-ORFS, AG-ÜWM

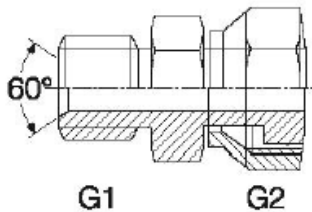

Gewinde 1	Gewinde 2	Art.-Nr.:
1/4"	9/16-18 UNF	A 04BM-04ORF
1/4"	11/16-16 UNF	A 04BM-06ORF
3/8"	11/16-16 UNF	A 06BM-06ORF
3/8"	13/16-16 UNF	A 06BM-08ORF
1/2"	11/16-16 UNF	A 08BM-06ORF
1/2"	13/16-16 UNF	A 08BM-08ORF
1/2"	1-14 UNF	A 08BM-10ORF
5/8"	1-14 UNF	A 10BM-10ORF
3/4"	1-14 UNF	A 12BM-10ORF
3/4"	13/16-12 UNF	A 12BM-12ORF
1"	13/16-12 UNF	A 16BM-12ORF
1"	17/16-12 UNF	A 16BM-16ORF

ORFS - Verschraubungen Schott Verschraubung AG-AG

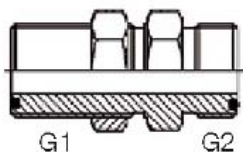

Gewinde 1	Gewinde 2	Art.-Nr.:
9/16-18 UNF	9/16-18 UNF	A 04ORMSCHOTT-04ORM
11/16-16 UNF	11/16-16 UNF	A 06ORMSCHOTT-06ORM
13/16-16 UNF	13/16-16 UNF	A 08ORMSCHOTT-08ORM
1-14 UNF	1-14 UNF	A 10ORMSCHOTT-10ORM
13/16-12 UNF	13/16-12 UNF	A 12ORMSCHOTT-12ORM
17/16-12 UNF	17/16-12 UNF	A 16ORMSCHOTT-16ORM

Änderungen vorbehalten! Andere Abmessungen + Ausführungen auf Anfrage.

ORFS - Verschraubungen Winkel Verschraubung 90°, AG-AG

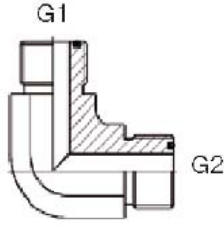

Gewinde 1	Gewinde 2	Art.-Nr.:
9/16-18 UNF	9/16-18 UNF	A 04ORM-04ORM90F
11/16-16 UNF	11/16-16 UNF	A 06ORM-06ORM90F
13/16-16 UNF	13/16-16 UNF	A 08ORM-08ORM90F
1-14 UNF	1-14 UNF	A 10ORM-10ORM90F
13/16-12 UNF	13/16-12 UNF	A 12ORM-12ORM90F
17/16-12 UNF	17/16-12 UNF	A 16ORM-16ORM90F

ORFS - Verschraubungen Winkel Schott-Verschraubung 90°, AG-AG

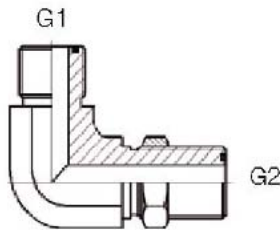

Gewinde 1	Gewinde 2	Art.-Nr.:
9/16-18 UNF	9/16-18 UNF	A 04ORM-04ORM90FSCHOTT
11/16-16 UNF	11/16-16 UNF	A 06ORM-06ORM90FSCHOTT
13/16-16 UNF	13/16-16 UNF	A 08ORM-08ORM90FSCHOTT
1-14 UNF	1-14 UNF	A 10ORM-10ORM90FSCHOTT
13/16-12 UNF	13/16-12 UNF	A 12ORM-12ORM90FSCHOTT
17/16-12 UNF	17/16-12 UNF	A 16ORM-16ORM90FSCHOTT

ORFS - Verschraubungen T - Verschraubung, AG-AG-AG

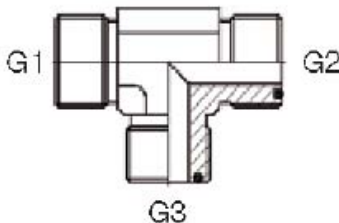

Gewinde 1	Gewinde 2	Gewinde 3	Art.-Nr.:
9/16-18 UNF	9/16-18 UNF	9/16-18 UNF	A 04ORM-04ORM-04ORM
11/16-16 UNF	11/16-16 UNF	11/16-16 UNF	A 06ORM-06ORM-06ORM
13/16-16 UNF	13/16-16 UNF	13/16-16 UNF	A 08ORM-08ORM-08ORM
1-14 UNF	1-14 UNF	1-14 UNF	A 10ORM-10ORM-10ORM
13/16-12 UNF	13/16-12 UNF	13/16-12 UNF	A 12ORM-12ORM-12ORM
17/16-12 UNF	17/16-12 UNF	17/16-12 UNF	A 16ORM-16ORM-16ORM

Änderungen vorbehalten! Andere Abmessungen + Ausführungen auf Anfrage.

ORFS - Verschraubungen T - Verschraubung, AG-AG-ÜWM

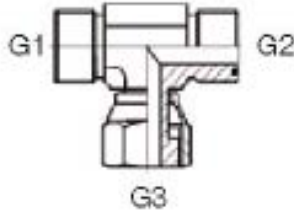

Gewinde 1	Gewinde 2	Gewinde 3	Art.-Nr.:
9/16-18 UNF	9/16-18 UNF	9/16-18 UNF	A 04ORM-04ORF-04ORF
11/16-16 UNF	11/16-16 UNF	11/16-16 UNF	A 06ORM-06ORF-06ORF
13/16-16 UNF	13/16-16 UNF	13/16-16 UNF	A 08ORM-08ORF-08ORF
1-14 UNF	1-14 UNF	1-14 UNF	A 10ORM-10ORF-10ORF
13/16-12 UNF	13/16-12 UNF	13/16-12 UNF	A 12ORM-12ORF-12ORF
17/16-12 UNF	17/16-12 UNF	17/16-12 UNF	A 16ORM-16ORF-16ORF

ORFS - Verschraubungen T - Verschraubung, AG-ÜWM-AG

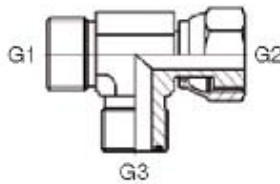

Gewinde 1	Gewinde 2	Gewinde 3	Art.-Nr.:
9/16-18 UNF	9/16-18 UNF	9/16-18 UNF	A 04ORM-04ORF-04ORM
11/16-16 UNF	11/16-16 UNF	11/16-16 UNF	A 06ORM-06ORF-06ORM
13/16-16 UNF	13/16-16 UNF	13/16-16 UNF	A 08ORM-08ORF-08ORM
1-14 UNF	1-14 UNF	1-14 UNF	A 10ORM-10ORF-10ORM
13/16-12 UNF	13/16-12 UNF	13/16-12 UNF	A 12ORM-12ORF-12ORM
17/16-12 UNF	17/16-12 UNF	17/16-12 UNF	A 16ORM-16ORF-16ORM

ORFS - Verschraubungen Reduzier Verschraubung IG-AG

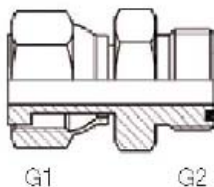

Gewinde 1	Gewinde 2	Art.-Nr.:
11/16-16 UNF	9/16-18 UNF	A 06ORF-04ORM
13/16-16 UNF	11/16-16 UNF	A 08ORF-06ORM
1-14 UNF	11/16-16 UNF	A 10ORF-06ORM
13/16-12 UNF	11/16-16 UNF	A 12ORF-06ORM
13/16-12 UNF	13/16-16 UNF	A 12ORF-08ORM
17/16-12 UNF	1-14 UNF	A 16ORF-10ORM

Änderungen vorbehalten! Andere Abmessungen + Ausführungen auf Anfrage.

ORFS - Verschraubungen
Winkel Verschraubung 90°, AG-ÜWM
mit vormontierter Überwurfmutter

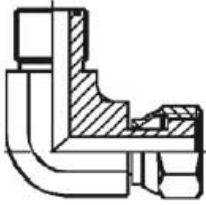

Gewinde 1	Gewinde 2	Art.-Nr.:
9/16-18 UNF	9/16-18 UNF	A 04ORM-04ORF90F
11/16-16 UNF	11/16-16 UNF	A 06ORM-06ORF90F
13/16-16 UNF	13/16-16 UNF	A 08ORM-08ORF90F
1-14 UNF	1-14 UNF	A 10ORM-10ORF90F
13/16-12 UNF	13/16-12 UNF	A 12ORM-12ORF90F
17/16-12 UNF	17/16-12 UNF	A 16ORM-16ORF90F
111/16-12 UNF	111/16-12 UNF	A 20ORM-20ORF90F

ORFS - Verschraubungen
Gerader Adapter ORFS-BSP, AG-AG

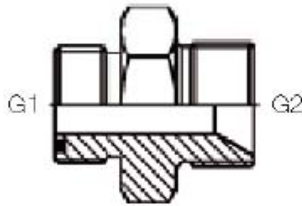

Gewinde 1	Gewinde 2	Art.-Nr.:
9/16-18 UNF	1/4"	A 04ORM-04BM
9/16-18 UNF	3/8"	A 04ORM-06BM
11/16-16 UNF	1/4"	A 06ORM-04BM
11/16-16 UNF	3/8"	A 06ORM-06BM
11/16-16 UNF	1/2"	A 06ORM-08BM
13/16-16 UNF	3/8"	A 08ORM-06BM
13/16-16 UNF	1/2"	A 08ORM-08BM
1-14 UNF	1/2"	A 10ORM-08BM
1-14 UNF	3/4"	A 10ORM-12BM
13/16-12 UNF	1/2"	A 12ORM-08BM
13/16-12 UNF	3/4"	A 12ORM-12BM
13/16-12 UNF	1"	A 12ORM-16BM
17/16-12 UNF	1"	A 16ORM-16BM

ORFS - Verschraubungen
Winkel Einschraubverschraubung ORFS-BSP 90°, AG-AG
Einstellbar mit Kontermutter

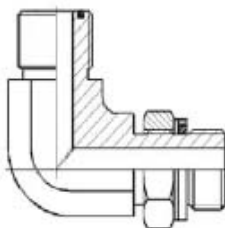

Gewinde 1	Gewinde 2	Art.-Nr.:
9/16-18 UNF	1/4"	A 04ORM-04BO90F
11/16-16 UNF	3/8"	A 06ORM-06BO90F
11/16-16 UNF	1/2"	A 06ORM-08BO90F
13/16-16 UNF	1/2"	A 08ORM-08BO90F
1-14 UNF	1/2"	A 10ORM-08BO90F
1-14 UNF	3/4"	A 10ORM-12BO90F
13/16-12 UNF	3/4"	A 12ORM-12BO90F
13/16-12 UNF	1"	A 12ORM-16BO90F
17/16-12 UNF	1"	A 16ORM-16BO90F

Änderungen vorbehalten! Andere Abmessungen + Ausführungen auf Anfrage.

ORFS - Verschraubungen

Winkel Einschraubverschraubung ORFS-BSP 45°, AG-AG

Einstellbar mit Kontermutter

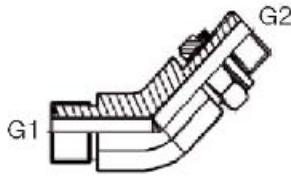

Gewinde 1	Gewinde 2	Art.-Nr.:
9/16-18 UNF	1/4"	A 04ORM-04BO45F
11/16-16 UNF	3/8"	A 06ORM-06BO45F
11/16-16 UNF	1/2"	A 06ORM-08BO45F
13/16-16 UNF	3/8"	A 08ORM-08BO45F
1-14 UNF	1/2"	A 10ORM-08BO45F
13/16-12 UNF	3/4"	A 12ORM-12BO45F
17/16-12 UNF	1"	A 16ORM-16BO45F

ORFS - Verschraubungen

Einstellbare T - Einschraubverschraubung, ORFS-ORFS-BSP

Einstellbar mit Kontermutter

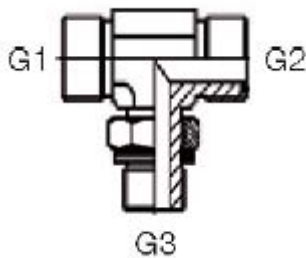

Gewinde 1	Gewinde 2	Gewinde 3	Art.-Nr.:
9/16-18 UNF	9/16-18 UNF	1/4"	A 04ORM-04ORM-04BO
11/16-16 UNF	11/16-16 UNF	3/8"	A 06ORM-06ORM-06BO
13/16-16 UNF	13/16-16 UNF	1/2"	A 08ORM-08ORM-08BO
1-14 UNF	1-14 UNF	1/2"	A 10ORM-10ORM-08BO
1-14 UNF	1-14 UNF	3/4"	A 10ORM-10ORM-1"BO
13/16-12 UNF	13/16-12 UNF	3/4"	A 12ORM-12ORM-12BO
17/16-12 UNF	17/16-12 UNF	1"	A 16ORM-16ORM-16BO

ORFS - Verschraubungen

Gerader Adapter, ORFS-JIC

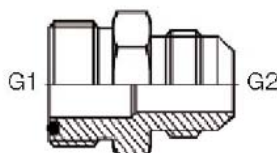

Gewinde 1	Gewinde 2	Art.-Nr.:
9/16-18 UNF	7/16-20 JIC	A 04ORM-07JM
11/16-16 UNF	1/2-20 JIC	A 06ORM-08JM
11/16-16 UNF	9/16-18 JIC	A 06ORM-09JM
13/16-16 UNF	3/4-16 JIC	A 08ORM-12JM
1-14 UNF	7/8-14 JIC	A 10ORM-14JM
13/16-12 UNF	11/16-12 JIC	A 12ORM-17JM
17/16-12 UNF	15/16-12 JIC	A 16ORM-21JM

Änderungen vorbehalten! Andere Abmessungen + Ausführungen auf Anfrage.

ORFS - Verschraubungen Gerader Adapter, ORFS-metrisch

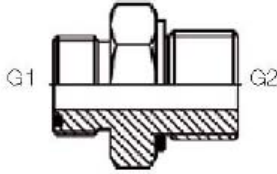

Gewinde 1	Gewinde 2	Art.-Nr.:
9/16-18 UNF	M 14x1,5	A 04ORM-14ME
11/16-16 UNF	M 16x1,5	A 06ORM-16ME
13/16-16 UNF	M 18x1,5	A 08ORM-18ME
1-14 UNF	M 22x1,5	A 10ORM-22ME

ORFS - Verschraubungen Gerade Verbindung ÜWM-ÜWM mit vormontierter Überwurfmutter

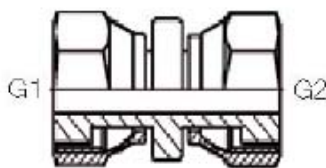

Gewinde 1	Gewinde 2	Art.-Nr.:
9/16-18 UNF	9/16-18 UNF	A 04ORF-04ORF
11/16-16 UNF	11/16-16 UNF	A 06ORF-06ORF
13/16-16 UNF	13/16-16 UNF	A 08ORF-08ORF
1-14 UNF	1-14 UNF	A 10ORF-10ORF
13/16-12 UNF	13/16-12 UNF	A 12ORF-12ORF
17/16-12 UNF	17/16-12 UNF	A 16ORF-16ORF
1 11/16-12 UNF	1 11/16-12 UNF	A 20ORF-20ORF
2-12 UNF	2-12 UNF	A 24ORF-24ORF

Änderungen vorbehalten! Andere Abmessungen + Ausführungen auf Anfrage.

ORFS - Verschraubungen Verschlußstopfen



Gewinde 1	Art.-Nr.:
9/16-18 UNF	A 04ORM-V
11/16-16 UNF	A 06ORM-V
13/16-16 UNF	A 08ORM-V
1-14 UNF	A 10ORM-V
13/16-12 UNF	A 12ORM-V
17/16-12 UNF	A 16ORM-V
1 11/16-12 UNF	A 20ORM-V
2-12 UNF	A 24ORM-V

ORFS - Verschraubungen Verschlußkappe



Gewinde 1	Art.-Nr.:
9/16-18 UNF	A 04ORF-V
11/16-16 UNF	A 06ORF-V
13/16-16 UNF	A 08ORF-V
1-14 UNF	A 10ORF-V
13/16-12 UNF	A 12ORF-V
17/16-12 UNF	A 16ORF-V
1 11/16-12 UNF	A 20ORF-V
2-12 UNF	A 24ORF-V

ORFS – Verschraubungen Schottmutter



Gewinde	Art.-Nr.:
9/16-18 UNF	A 04ORFS-SM
11/16-16 UNF	A 06ORFS-SM
13/16-16 UNF	A 08ORFS-SM
1-14 UNF	A 10ORFS-SM
13/16-12 UNF	A 12ORFS-SM
17/16-12 UNF	A 16ORFS-SM
1 11/16-12 UNF	A 20ORFS-SM
2-12 UNF	A 24ORFS-SM

Änderungen vorbehalten! Andere Abmessungen + Ausführungen auf Anfrage.

ORFS – Verschraubungen ORING für ORFS Anschlüsse



Abmessung	Art.-Nr.:
7,66x1,78	OR04ORFS
9,25x1,78	OR06ORFS
12,42x1,78	OR08ORFS
15,60x1,78	OR10ORFS
18,77x1,78	OR12ORFS
23,52x1,78	OR16ORFS
29,87x1,78	OR20ORFS
33,82x1,78	OR24ORFS

Änderungen vorbehalten! Andere Abmessungen + Ausführungen auf Anfrage.

KOMATSU – Verschraubungen Gerade Verschraubung JIS (metrisch) - BSP

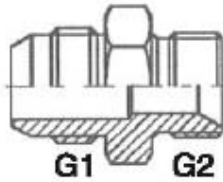

Gewinde 1	Gewinde 2	Art.-Nr.:
M 14x1,5	1/4"	A 14MJM-04BM
M 18x1,5	3/8"	A 18MJM-06BM
M 20x1,5	1/2"	A 20MJM-08BM
M 22x1,5	3/8"	A 22MJM-06BM
M 22x1,5	1/2"	A 22MJM-08BM
M 24x1,5	5/8"	A 24MJM-10BM
M 30x1,5	3/4"	A 30MJM-12BM
M 33x1,5	1"	A 33MJM-16BM

KOMATSU – Verschraubungen Gerade Verschraubung JIS (metrisch) - JIS (metrisch)

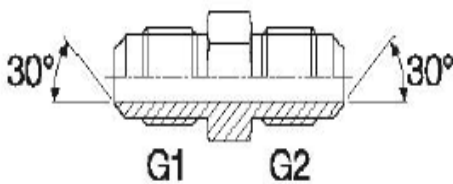

Gewinde 1	Gewinde 2	Art.-Nr.:
M 14x1,5	M 14x1,5	A 14MJM-14MJM
M 18x1,5	M 18x1,5	A 18MJM-18MJM
M 20x1,5	M 20x1,5	A 20MJM-20MJM
M 22x1,5	M 22x1,5	A 22MJM-22MJM
M 24x1,5	M 24x1,5	A 24MJM-24MJM
M 30x1,5	M 30x1,5	A 30MJM-30MJM
M 33x1,5	M 33x1,5	A 33MJM-33MJM

Änderungen vorbehalten! Andere Abmessungen + Ausführungen auf Anfrage.

KOMATSU – Verschraubungen Gerade Verschraubung BSP – JIS (zöllig)

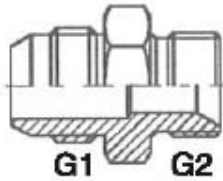

Gewinde 1	Gewinde 2	Art.-Nr.:
1/4"-19	1/4"	A 04BM-04BJM
3/8"-19	3/8"	A 06BM-06BJM
1/2"-14	3/8"	A 08BM-06BJM
1/2"-14	1/2"	A 08BM-08BJM
3/4"-14	3/4"	A 12BM-12BJM

KOMATSU – Verschraubungen Gerade Verschraubung JIS (zöllig) - JIS (zöllig)

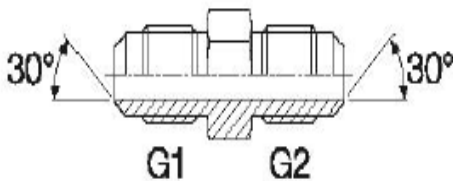

Gewinde 1	Gewinde 2	Art.-Nr.:
1/4"-19	M 14x1,5	A 04BJM-04BJM
3/8"-19	M 18x1,5	A 06BJM-06BJM
1/2"-14	M 20x1,5	A 08BJM-08BJM
3/4"-14	M 22x1,5	A 12BJM-12BJM

Änderungen vorbehalten! Andere Abmessungen + Ausführungen auf Anfrage.

KOMATSU – Verschraubungen Verschlußstopfen JIS (metrisch)

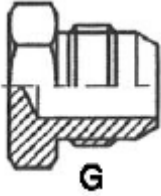

Gewinde	Art.-Nr.:
M 14x1,5	A 14MJM-V
M 16x1,5	A 16MJM-V
M 18x1,5	A 18MJM-V
M 20x1,5	A 20MJM-V
M 22x1,5	A 22MJM-V
M 24x1,5	A 24MJM-V
M 28x1,5	A 28MJM-V
M 30x1,5	A 30MJM-V
M 33x1,5	A 33MJM-V

KOMATSU – Verschraubungen Verschlußkappe JIS (metrisch)

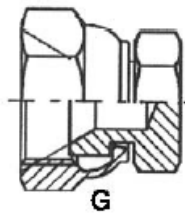

Gewinde	Art.-Nr.:
M 14x1,5	A 14MJF-V
M 16x1,5	A 16MJF-V
M 18x1,5	A 18MJF-V
M 20x1,5	A 20MJF-V
M 22x1,5	A 22MJF-V
M 24x1,5	A 24MJF-V
M 28x1,5	A 28MJF-V
M 30x1,5	A 30MJF-V
M 33x1,5	A 33MJF-V

KOMATSU – Verschraubungen Verschlußstopfen JIS (zöllig)

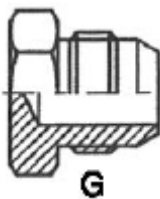

Gewinde	Art.-Nr.:
1/4"-19	A 04BJM-V
3/8"-19	A 06BJM-V
1/2"-14	A 08BJM-V
3/4"-14	A 12MJM-V
1"-11	A 16MJM-V

KOMATSU – Verschraubungen Verschlußkappe JIS (zöllig)

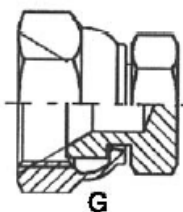

Gewinde	Art.-Nr.:
1/4"-19	A 14BJF-V
3/8"-19	A 16BJF-V
1/2"-14	A 18BJF-V
3/4"-14	A 20BJF-V
1"-11	A 22BJF-V

Änderungen vorbehalten! Andere Abmessungen + Ausführungen auf Anfrage.